



◀◀◀  
**In Vivo Imaging Solution**



◀◀◀  
**Neural Signal Regulation Solution**



◀◀◀  
**Pathological Section Solution**



◀◀◀  
**Cellular and Molecular Biology Research Solution**



**PRODUCT CATALOGUE**

[www.animalab.eu](http://www.animalab.eu)  
[info@animalab.eu](mailto:info@animalab.eu)

[www.rwdstco.com](http://www.rwdstco.com)  
[rwd@rwdstco.com](mailto:rwd@rwdstco.com)

# Speed up Life Science Research Achieve Better Healthcare for Human & Animals



Learn more about us at:  
[www.rwdstco.com](http://www.rwdstco.com)

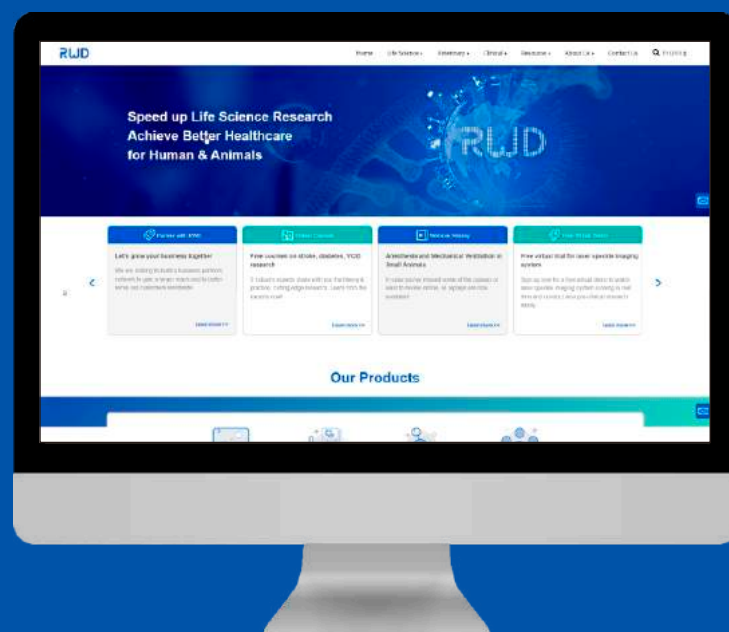



# CONTENTS

---

## **Animal Surgery and Modeling Solution** ..... 01

Stereotaxic Instruments	1
Precise Impactor	12
Animal Anesthesia Machine	14
Animal Ventilator	23
Surgical Auxiliary Equipment	25
Veterinary Laser Therapy	30
Smart Animal ICU	31
Surgical Instruments & Matrix	32

## **Neural Signal Regulation Solution** ..... 33

Optogenetics System	33
Fiber Photometry System	36
Micropipette Puller	39
Motorized Micromanipulator	40

## **In Vivo Imaging Solution** ..... 41

Laser Speckle Imaging System	41
------------------------------	----

## **Animal Administration and Blood Sampling Solution** ..... 43

Drug Delivery Cannula	43
Osmotic Pumps	48
Blood Sampling and Administration System	49
Syringe Pumps	51

## **Pathological Section Solution** ..... 53

Rotary Microtome	53
Cryostat	55

## **Cellular and Molecular Biology Research Solution** 57

Single Cell Suspension Dissociator	57
Cell Separation Kit	58
CO <sub>2</sub> Incubator	59
Automated Cell Counters	61
Microcentrifuges	63

## **Surgical Instruments & Matrix** ..... 66

## Introduction

Established in 2002, RWD Life Science has been dedicated to being a leading manufacturer in research and veterinary equipments worldwide. We specialize in anesthesia, physiological and surgical equipments, which are used by pre-clinical researchers and veterinarians. Our mission is to provide high quality products and integrated solutions to our customers with prompt and professional support.

For more information about our products, such as Laser Speckle Perfusion Imager, Anesthesia Machine, Ventilator, Stereotaxic Instrument, Syringe Pump, Cannula System and Surgical tools etc., please check our website:

[www.rwdstco.com](http://www.rwdstco.com)

### **RWD Life Science Co., Ltd**

Add: 19-20/F, Building 7A, Shenzhen International Innovation Valley, Dashi 1st Road, Nanshan District, Shenzhen, Guangdong, China

Web: [www.rwdstco.com](http://www.rwdstco.com)

E-mail: [rwd@rwdstco.com](mailto:rwd@rwdstco.com)

### **RWD Life Science Inc.**

Add: 6540 Lusk Blvd, Suite C161 San Diego, CA 92121

Tel: 1-858-900-5879

Tech Support: [service@rwdstco.com](mailto:service@rwdstco.com)

# Animal Surgery and Modeling Solution

Stereotaxic instrument is an important research equipment widely used in many fields such as neuroanatomy, neurophysiology, neuropharmacology and neurosurgery. Up to now, RWD's stereotaxic instrument has helped global neuroscience researchers to publish more than 2300 articles in Cell, Nature, Science and other academic journals, and has been widely recognized in the industry.

- Meet the needs of rats, mice, guinea pigs, tree shrews, cats, rabbits, dogs, monkeys and other different animal experiments.
- Three kinds of accuracy 100μm, 10μm, 1μm are available.
- Except for the automated model 71000, other models can be upgraded to digital or dual manipulator models.



Automated Stereotaxic Instrument

Operation accuracy is 1μm;  
Built-in rodent brain atlas and three automatic programs.



Desktop Digital Stereotaxic Instrument

Add digital display module,  
displacement resolution 10μm.

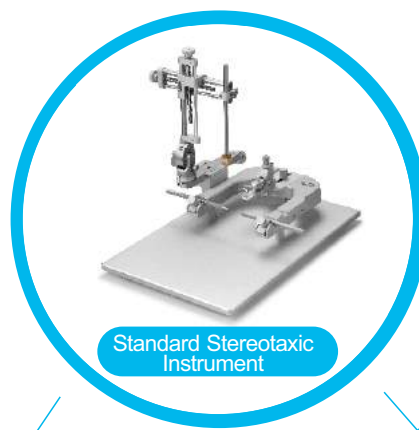

Standard Stereotaxic Instrument



Rotational Digital Stereotaxic Instrument

Easy to adjust the skull level.



Portable Stereotaxic Instrument

The height of the teeth bar and ear bar can be adjusted for easy adjustment of the cranial level.



Large Animal Stereotaxic Instrument

Used to stereotaxic experiments of cats, dogs, monkeys and other large animals.

# Small Animal Stereotaxic Instruments

## ▶ 71000 Automated Stereotaxic Instrument

The 71000 is an automated, high precise (1 $\mu$ m) and intelligent stereotaxic instrument integrated with rodent atlases and built-in software which allows for three automated procedures (skull window, tissue removal and multi-point programs) and It provides intuitive observation of the probe position relative to the brain area, which is much convenient, efficient and easy to operate. It greatly reduces error and damage caused by human operation. In addition, the anti-collision function would prevent animal from damage caused by wrong operation, which is much more safer.

### Features & Technical Parameters:

#### ● Precise

1. The stereotaxic instrument uses a stepping motor to control the manipulator, with a resolution of 1 $\mu$ m, which meets the needs of higher precision experiments.
2. Anti-backlash function can greatly eliminate the error caused by the gap between the motor wheels when the motor moves in the reverse direction.
3. Calibration function, which can calibrate the actual scale value on the manipulator and the reading on the software.



#### ● Convenient and efficient

1. The software integrates mouse and rat atlas, which can display the trajectory and position of the probe in real time.
2. Multiple control movement methods: micro-manipulation panel, software and computer keyboard to control the movement of the three-dimensional manipulators, the movement speed is adjustable.
3. When reaching the Bregma/Lambda point, you can set the Bregma/Lambda point as the origin with one key, and you can return to the origin with one key at any coordinate.
4. Skull window, tissue removal and multi-point programs, which can meet a variety of experimental needs, reduce injuries and errors caused by manual operations, and are easy to operate.

#### ● Safe

1. Z-axis retraction and motional collision function to prevent animal damage during moving.
2. The emergency stop button can immediately stop the running program to avoid animal damage caused by operating errors.

### Tissue removal module (optional)

It is used for the removal of brain tissue.

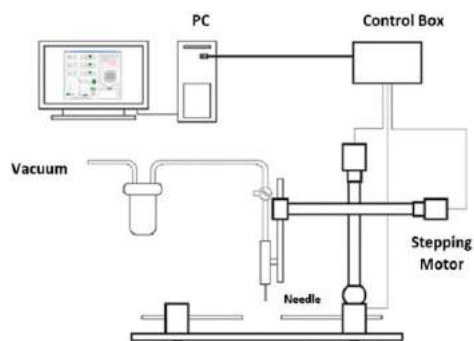

Auto >>>

Handle >>>

More smoothness, less damage

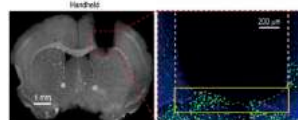
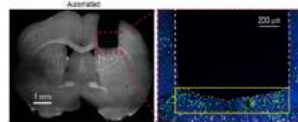

Improve neuron survival, better imaging

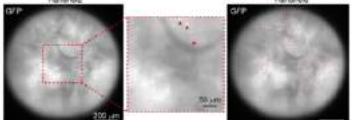
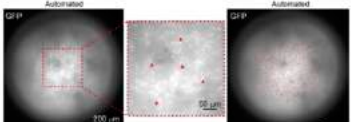

**Features :**

- Configure a vacuum pump, the software can set the suction depth, sequence, and number of repetitions to automatically and accurately remove brain tissue;
- The software can set the depth and speed of lens implantation, one-click implantation;
- Ensure the flatness of the wound end surface and reduce damage;
- Improve the survival of neurons per unit area and enhance imaging effect;
- Reduce the error caused by traditional manual operation and enhance the repeatability of experiment.

**▶ Rotational Digital Stereotaxic Instrument**

The 69100 Rotational Digital Stereotaxic allows for quick and precise adjustment of the animal's skull level and alignment of the sagittal suture without the need of repeated setting Bregma or repeated fixing animal, which can greatly reduce the time required for skull level adjustment. The Alignment Indicator is used to indicate the level and also to improve the perpendicularity of the syringe or cannula to the brain, increasing of positioning

**Features:**

- The rotation adaptor can adjust head position in 3 dimensional space.
- The displacement distance of the head rotating adaptor X, Y and Z is 30mm, the left and right angles are rotated  $\pm 15^\circ$ , the front and rear swing angle is  $\pm 10^\circ$ , and the bottom plate is rotated  $\pm 10^\circ$ .
- 0.01mm resolution in digital display, supply by battery, no electronic interference.
- The UP indicator on z-axis prevents z-axis manipulate from misoperation.
- The manipulator drives by electrode more than 100,000 times with minimum deviation.
- Double head screw design makes the 3-axis more stable and accurate.

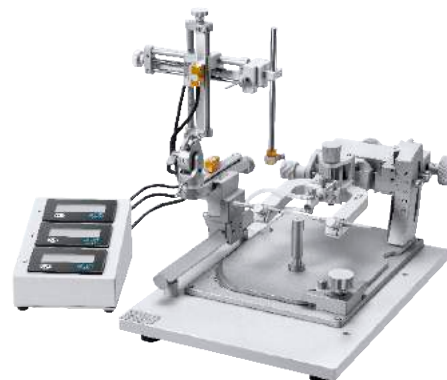

**Recommended Accessories:**



**40X Center Magnifier(69130)**

1. Used to assist in coinciding the Bregma point with the crossover point of the center height gauge, the crossover point is the crossover point of the rotation axis, the coordinates of point remain unchanged when rotating, so there is no need to repeat set up the Bregma point when adjusting the level.
2. Help to find Bregma and Lambda points.



**Alignment Indicator(69131)**

When the two probes touch the skull, the difference in the deflection angle of the micrometer pointer can feedback whether the height of the animal's head is horizontal from left to right, front to back. The resolution of the Alignment Indicator is 0.01mm.

**Order Information:**

Model	Specification
69100	Ultra Precise Rotational Stereotaxic Instrument for Mouse, Digital, SGL M, 69110 Adaptor Incl.
69101	Ultra Precise Rotational Stereotaxic Instrument for Mouse, Digital, Dual M, 69110 Adaptor Incl.
69102	Ultra Precise Rotational Stereotaxic Instrument for Rat, Digital, SGL M, 69112 Adaptor Incl.
69103	Ultra Precise Rotational Stereotaxic Instrument for Rat, Digital, Dual M, 69112 Adaptor Incl.
69130	Centering Scope 40X.
69131	Alignment Indicator.

## ▶ Standard Stereotaxic Instrument

Classical U-type base design, professional services in the laboratory for 17 years!

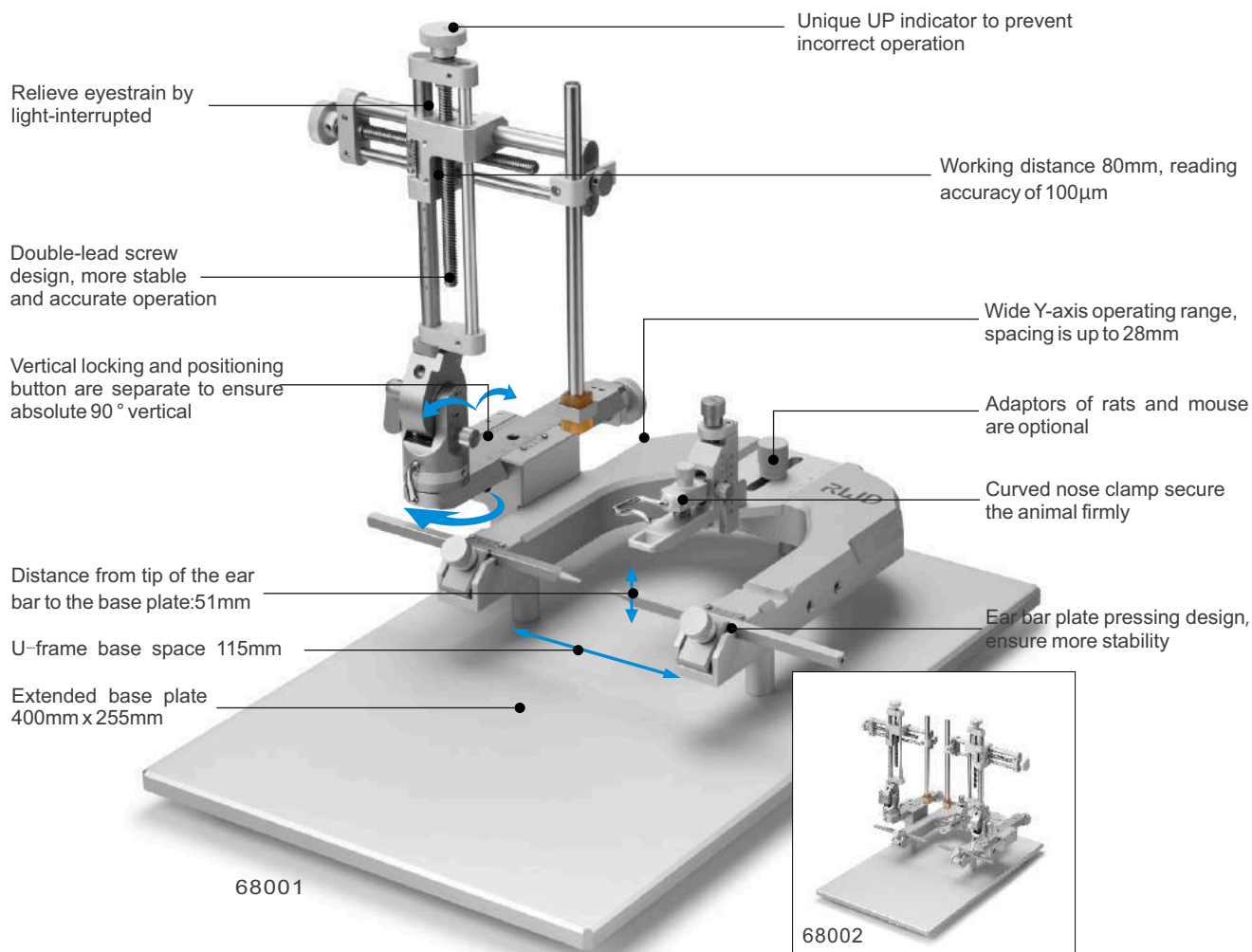

### Composition:

68001 and 68002 are complete sets of stereotaxic (see figure), both containing 68861N base plate, 68401 three-dimensional manipulator - left, 68021 rat adaptor, 68301 rat 18° ear bar, 68201 standard holder, and 68002 includes an extra 68402 three-dimensional manipulator - right.

### Order Information:

Model	Product Description
68001	Stereotaxic for Rat, SGL M, 18 Deg
68002	Stereotaxic for Rat, Dual M, 18 Deg
68005	Stereotaxic for Rat, SGL M, 45 Deg
68006	Stereotaxic for Rat, Dual M, 45 Deg
68037	Stereotaxic for Mouse, SGL M, 68030 Adaptor Incl
68038	Stereotaxic for Mouse, Dual M, 68030 Adaptor Incl
68043	Stereotaxic for Mouse, SGL M, 68055 Adaptor, 60 Deg
68044	Stereotaxic for Mouse, Dual M, 68055 Adaptor, 60 Deg
68535	Stereotaxic for Mouse, SGL M, 68077 Adaptor, 60 Deg
68536	Stereotaxic for Rat, SGL M, 68078 Adaptor, 18 Deg
68861N	Stereotaxic Base Plate, Standard

## ► Desktop Digital Stereotaxic Instrument

Digital displacement display, higher accuracy, higher efficiency!

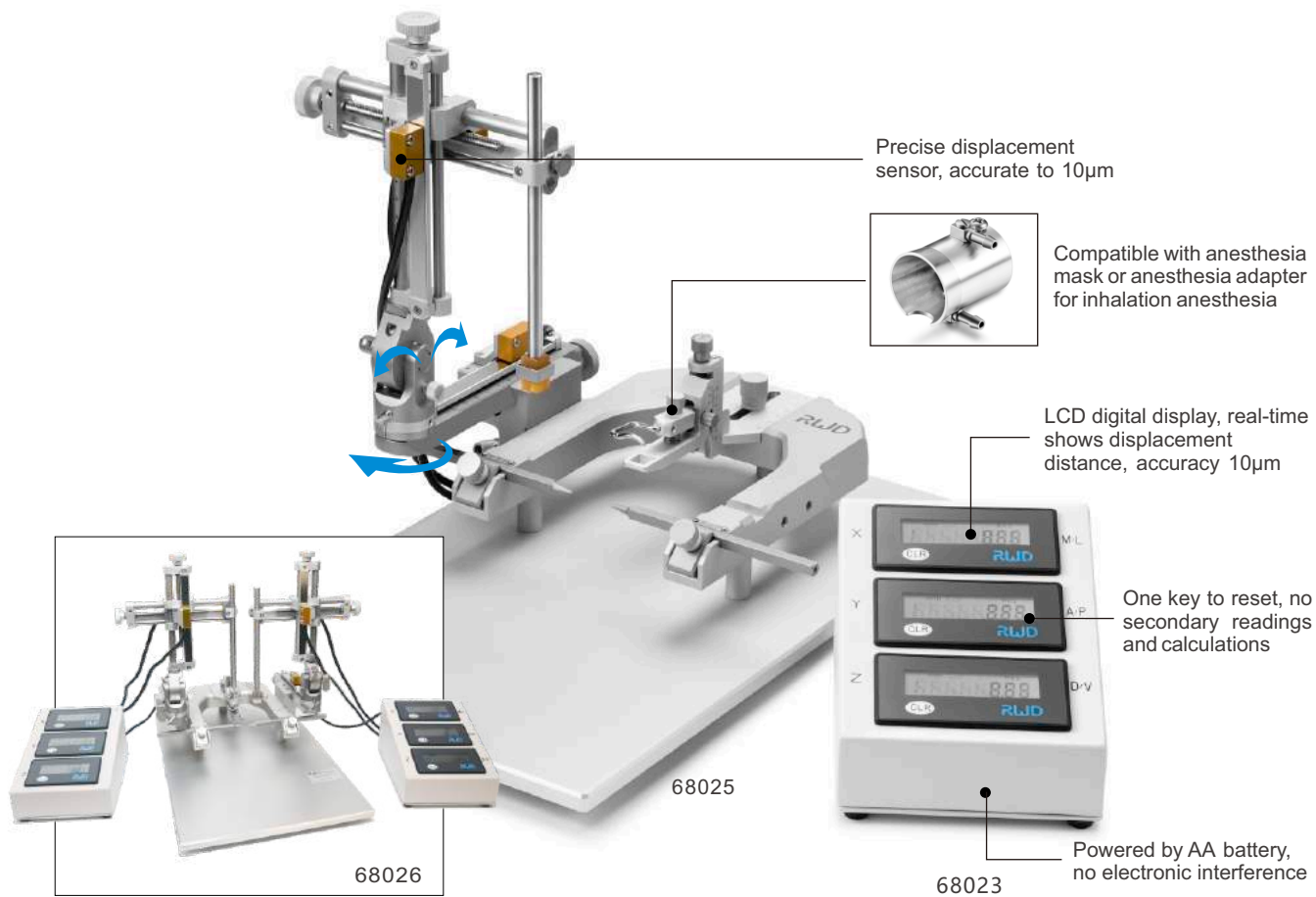

### Composition:

68025 and 68026 are complete sets of stereotaxic (see figure), both containing 68861N base plate, 68409 3-Axis Digital Manipulator, Left-hand, 68021 rat adaptor, 68301 rat 18 ° ear bar, 68201 standard holder, 68026 includes an extra 68410 3-Axis Digital Manipulator, Right-hand.

### Order Information:

Model	Product Description
68025	Stereotaxic for Rat, SGL M, Digital, 18 Deg
68026	Stereotaxic for Rat, Dual M, Digital, 18 Deg
68027	Stereotaxic for Rat, SGL M, Digital, 45 Deg
68028	Stereotaxic for Rat, Dual M, Digital, 45 Deg
68018	Stereotaxic for Mouse, SGL M, Digital, 68030 Adaptor Incl
68019	Stereotaxic for Mouse, Dual M, Digital, 68030 Adaptor Incl
68045	Stereotaxic for Mouse, SGL M, Digital, 68055 Adaptor, 60 Deg
68046	Stereotaxic for Mouse, Dual M, Digital, 68055 Adaptor, 60 Deg
68537	Stereotaxic for Mouse, SGL M, Digital, 68077 Adaptor, 60 Deg
68538	Stereotaxic for Rat, SGL M, Digital, 68078 Adaptor, 18 Deg
68861N	Stereotaxic Base Plate, Standard



## ▶ Compact Mouse Stereotaxic Instrument

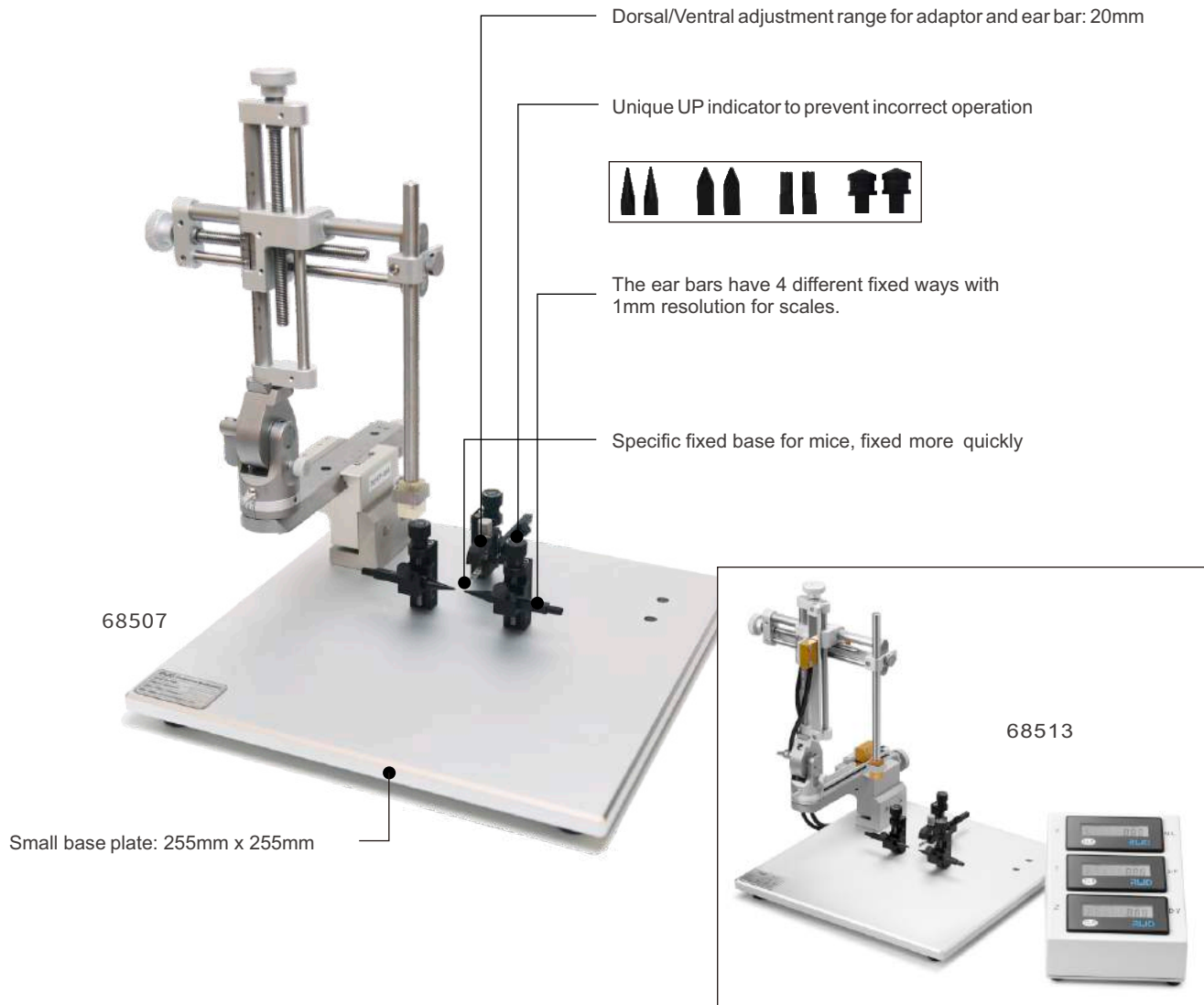

### Order Information:

Model	Product Description
68507	Stereotaxic for Mouse, SGL M, Portable
68510	Stereotaxic for Mouse, Dual M, Portable
68513	Stereotaxic for Mouse, Digital and Portable, SGL M
68516	Stereotaxic for Mouse, Digital and Portable, Dual M

## ▶ Portable Rat & Mouse Stereotaxic Instrument

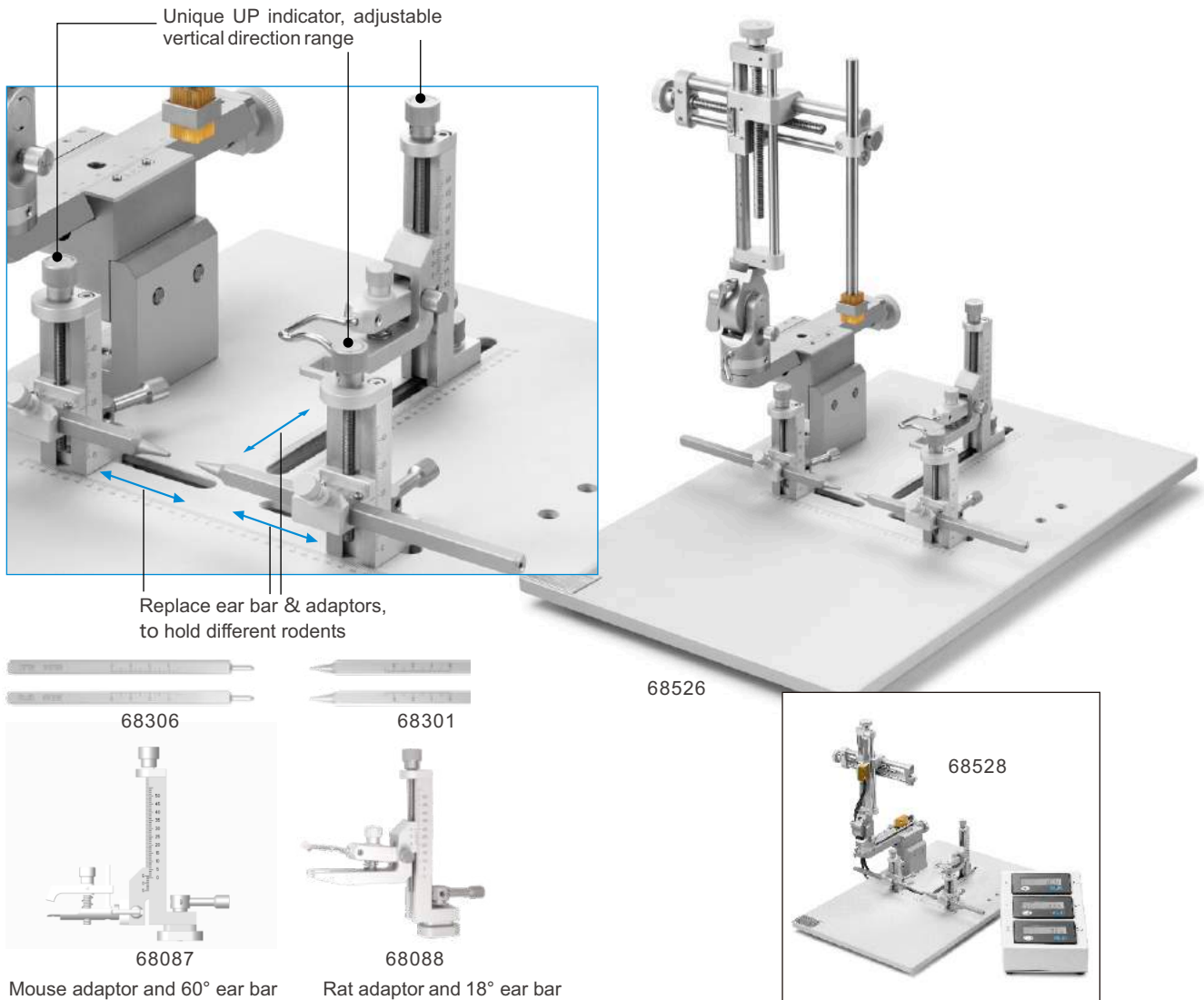

**Composition:**

68526 is a complete set stereotaxic configurations, containing 68867S base plate, 68401 three-dimensional manipulator - left, 68087 mouse adaptor and 68088 rat adaptor, 68301 rat 18° ear bars and 68306 mouse 60 ° ear bars, 68201 standard holder; Digital version 68528 adds digital display module.

**Order Information:**

Model	Product Description
68526	Stereotaxic for Rat and Mouse, SGL M, Portable
68527	Stereotaxic for Rat and Mouse, Dual M, Portable
68528	Stereotaxic for Rat and Mouse, SGL M, Digital and Portable
68529	Stereotaxic for Rat and Mouse, Dual M, Digital and Portable
68867S	Stereotaxic Base Plate for Rat and Mouse, Portable, SGL M
68867D	Stereotaxic Base Plate for Rat and Mouse, Portable, Dual M
68087	Mouse adaptor (Stereotaxic for Rat and Mouse )
68088	Rat adaptor (Stereotaxic for Rat and Mouse )

## ► Large Animal Stereotaxic Instrument

Adaptors are available for dogs, monkeys, pigs, and other large animals.

Unique jaw plate design better stabilizes the heads of large animals of varying weights.

Y-axis rail design, longer moving range:  $\pm 100\text{mm}$ , 1mm resolution

Combined with microdriver, the resolution of vertical reading can be promoted to  $50\mu\text{m}$

Holds up to six manipulator arms

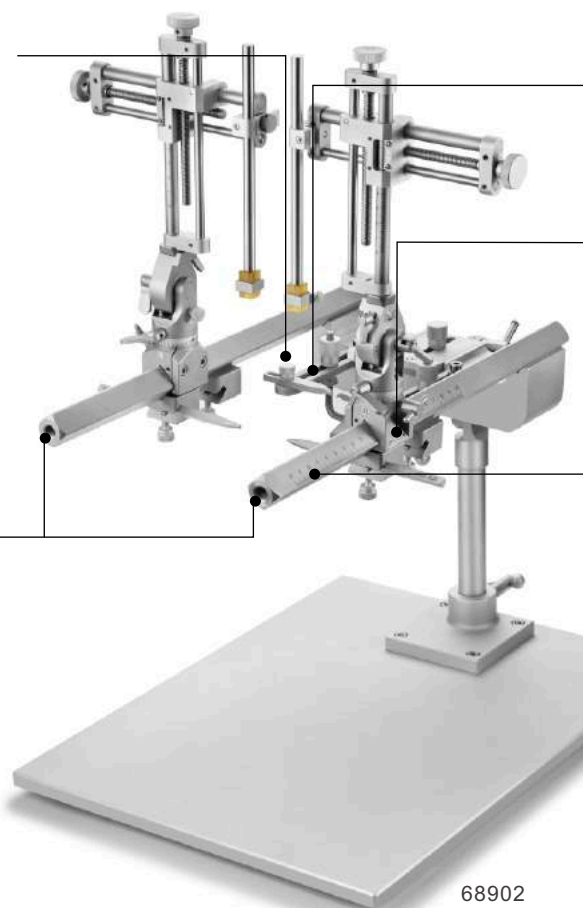

### Composition:

68902 is a complete set of stereotaxic, containing 68868N base plate, 68941 two-dimensional manipulator - left, 68942 two-dimensional manipulator - right, 68081 dog/monkey adaptor, 68303 cat/monkey 18° ear bar, 68201 standard holder; Digital version 68916 adds digital display module.

### Order Information:

Model	Product Description
68901	Stereotaxic for Dog/Monkey, SGL M, 68081 Adaptor Incl
68902	Stereotaxic for Dog/Monkey, Dual M, 68081 Adaptor Incl
68911	Stereotaxic for Cat/Monkey, SGL M, 68041 Adaptor Incl
68912	Stereotaxic for Cat/Monkey, Dual M, 68041 Adaptor Incl
68916	Stereotaxic for Dog/Monkey, Digital, SGL M, 68081 Adaptor Incl
68917	Stereotaxic for Dog/Monkey, Digital, Dual M, 68081 Adaptor Incl
68920	Stereotaxic for Cat/Monkey, Digital, SGL M, 68041 Adaptor Incl
68921	Stereotaxic for Cat/Monkey, Digital, Dual M, 68041 Adaptor Incl
68868N	Stereotaxic Base Plate for Dog, Pig, Monkey etc
68941	2-axis Manip for Dog/Monkey Stereotaxic, Left Hand
68942	2-axis Manip for Dog/Monkey Stereotaxic, Right Hand
68944	2-axis Digital Manip for Dog/Monkey Stereotaxic, Left Hand
68945	2-axis Digital Manip for Dog/Monkey Stereotaxic, Right Hand

# Stereotaxic Instruments Accessories

## Electrode Holder

68201 Standard Probe Holder-Corner



V-groove design, widely used for syringe needles or electrodes with diameter 0.3mm-1.5mm.

68211 Cannula Holder



Compatible with stereotaxic instruments with dual manipulators. Holds electrodes or cannulas of 2.1mm to 5.0mm in diameter.

68210 Electrode Holder



Holder is specifically designed for electrophysiological experiments. Two electrodes, controlled individually, can be located very close to each other. Holds thin electrodes with diameter from 0.7mm to 2.5mm.

## Cannula Holders

68205 Cannula Holder



It's made of metal. Suitable for holding the single cannula or double cannula with the outer diameter of 3.5mm plastic.

68217 Cannula Holder



Suitable for holding the single cannula or double cannula with the outer diameter of 3.5mm plastic base.

68214/68215 Ceramic Ferrule Holder



Hold cannula or Ceramic Ferrule during implantation.

- Versions for Ø1.25 mm — 68214 Cannula or Ceramic Ferrule.
- Versions for Ø2.5 mm — 68215 Cannula or Ceramic Ferrule.

## Multi-function Holders

68202 Large Probe Holder



Lateral fixation, holds micro syringe needles, large diameter electrodes and flexible drill handles etc, V-groove design with 6mm-12mm diameters.

68218 Syringe Holder



Holder is applicable for micro-injection, which holds syringe and needle simultaneously, and the clamping of the syringe is more stable, the syringe holding range is 3mm to 12mm and needle's is 0.3mm to 1.5mm.

68605 Microdrill Holder



Holder secures the microdrill to stereotaxic instruments. Controls the depth of drilling by the manipulator. Easy and accurate operation protects brain tissue from damage caused by excessive drilling. Holds the microdrill with diameter about 14.5mm.

## Adaptors

### Mouse Adaptors

68030 Mouse/Neonatal Rat Adaptor  
(with 18° ear bars 68034 and 45° ear bars 68313)

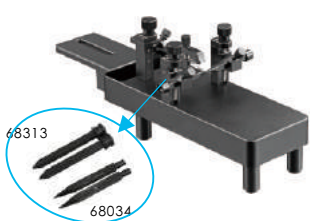

This adaptor can not only fix the mouse and neonatal rat head, but also avoid damage to the skull. Four kinds of earstick tips are available, the height of the earstick and earstick are adjustable, and the adjustment range is 20mm.

68055 Mouse Adaptor



It holds the mouse head by a palate and incisor, and offers vertical regulation to make the head level or at certain angle. The vertical adjustable range from +10mm to -20mm, with 100µm resolution; Horizontal adjustable range of 43.5mm; Horizontal rotatable range of 35°.

### 68057 Mouse Gas Anesthesia Head Holder

This model offers maximal adjustment for positioning the head. The adaptor can rotate the head to multi angle without blocking the anesthetic gas delivery.

- Vertical adjustable range: 30mm (+10mm~-20mm), with 100 $\mu$ m accuracy.
- Vertical rotatable range: 70° (-35°~+35°), with 5° accuracy.
- Horizontal rotatable range: 70° (-35°~+35°), with 5° accuracy.
- Horizontal adjustable range: 43.5mm
- Diameter of inlet/outlet of the mask: 2mm

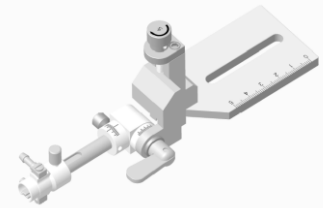

## Rat Adaptors

### 68021 Rat Adaptor

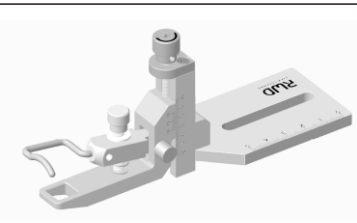

It holds rat head firmly through incisor, nose clip and ear bars. This adaptor can be adjusted 30 mm vertically along dovetail slide with 100 $\mu$ m resolution and 50mm horizontally, which makes it applicable for rats of different weight.

### 68053 Rat Anesthesia Adaptor



This adaptor integrates the gas anesthesia mask function while hold the rat head firmly. The adaptor can rotate the head to multi angle without blocking the anesthetic gas delivery.

- Vertical adjustment range is 30mm (-20mm ~ + 10mm), with 100 $\mu$ m accuracy.
- Vertically rotatable range is 70°(-35° ~ + 35°), with 5°accuracy.
- Horizontal rotatable range is 70° (-35°~ + 35°), with 5°accuracy.
- Horizontal adjustment range is 43.5mm.

## Multi-function Adaptor

### 68091 Spinal Cord Adaptor for Rat & Mouse

The adaptor is ideal for spinal securing of rat and mouse. The base plate is 210mm(L) x 165mm(W) x 15mm(H), which can be attached to RWD 68000 series small animal stereotaxic instruments. There are 3 vertical bars and locking blocks, which can be easily disassembled through the T slots without wrench. The adjustment range of vertical bar is 56mm. The height of locking block can be easily adjusted by screw. This adaptor can be adjusted in Vertical/Lateral, Anterior/Posterior and Ventral/Dorsal directions. Standard accessories contain: Base plate, 3 vertical bars and locking blocks and spinal cord clamp (3 pairs).

#### Specifications:

- Accurate and reliable positioning.
- Wide various components and accessories can be used in module.
- Simple, fast and effective clamping and locking.
- Compatible with small animal stereotaxic instruments.

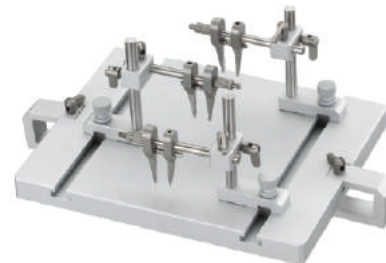

## Ear Bars

### RWD ear bar with the scale of 35mm,1mm resolution, square 6.15mm

68301



Ear Bars, Rat, 18 Deg.  
(0.8mm radius tip)

68302



Ear Bars, Rat, 45 Deg (for guinea pigs, prairie rats, birds, squirrel monkeys 0.8mm tip).

68306

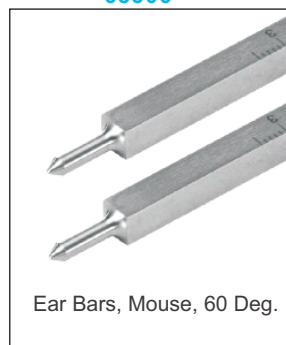

Ear Bars, Mouse, 60 Deg.

68314

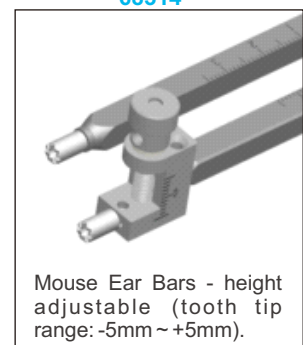

Mouse Ear Bars - height adjustable (tooth tip range: -5mm ~ +5mm).

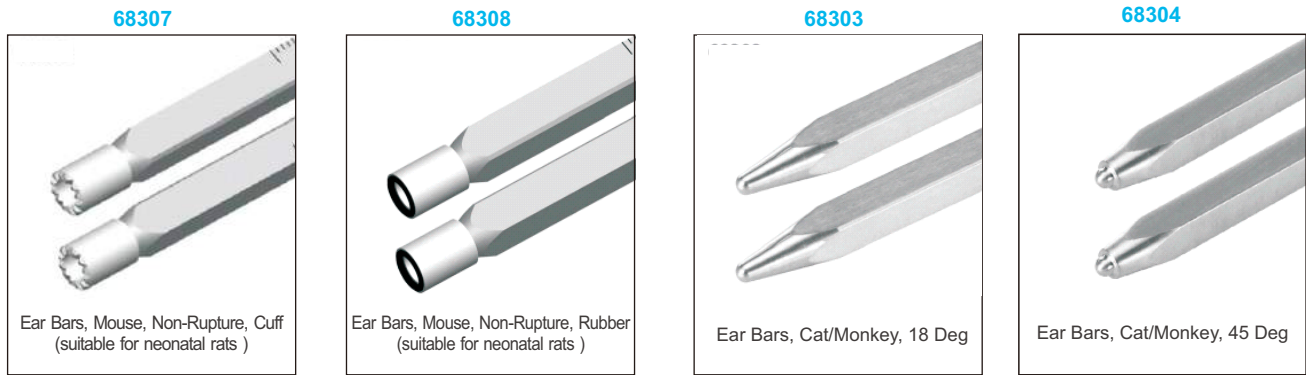

## Stereotaxic Frame Nosecone Masks

- This type of anesthetic masks are specifically designed to fit most stereotaxic frame and deliver anesthetic gases with minimal exposure during surgery. They are locked onto the adaptor with the cone opening toward the open “U”. The animal’s teeth is placed over the incisor bar.
- Two kinds of Stereotaxic Frame Nosecone Masks are available: one is “passive” mask with collinear inlet and outlet, and the other one is “active” mask with separate (non-collinear) inlet and outlet on both sides. the “passive” mask is used with charcoal canister only, and the “active” mask can be used with evacuation apparatus.

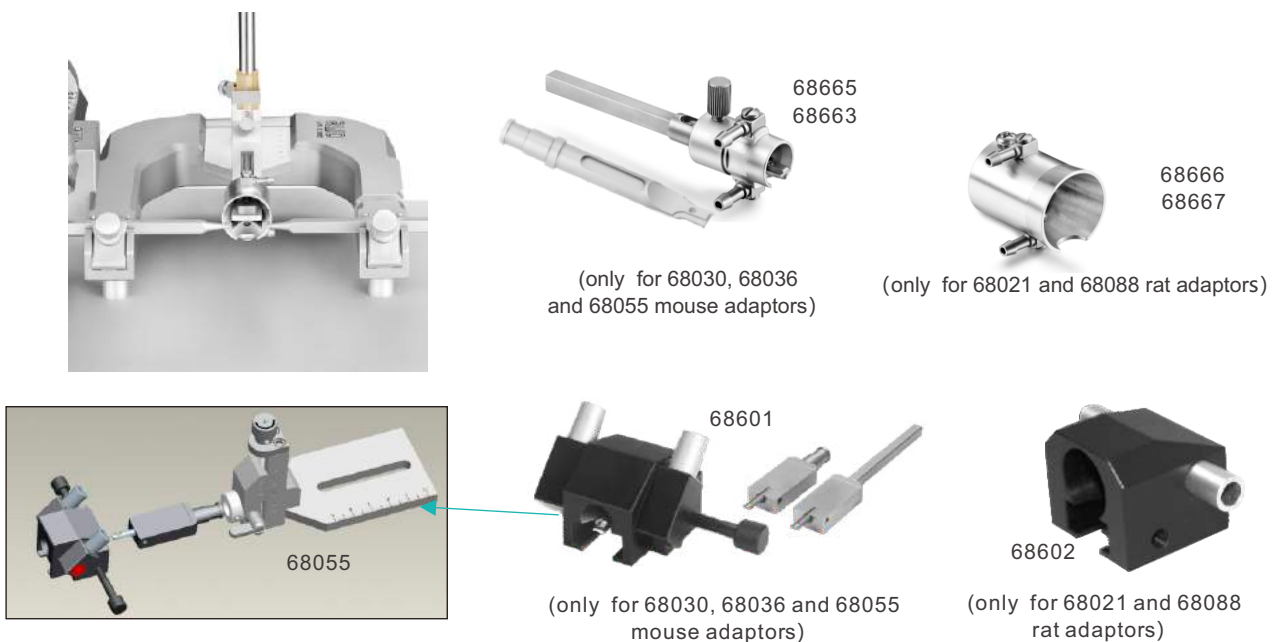

### Order Information:

Model	Product Description	Remarks
68601	Stereotaxic Anesthesia Mask Kit -mice or neonatal rats (<70g, Canister & Tubing included)	For Passive Scavenging
68602	Stereotaxic Anesthesia Mask Kit - rats (<300g, Canister & Tubing included)	
68663	Stereotaxic Anesthesia/Evacuation mask- mice or neonatal rats (<30g)	For Active Scavenging
68665	Stereotaxic Anesthesia/Evacuation mask- mice or neonatal rats (30~70g)	
68666	Stereotaxic Anesthesia/Evacuation mask- rats (<300g)	
68667	Stereotaxic Anesthesia/Evacuation mask- rats (>300g)	

# Precise Impactor

## 68099 II Precise Impactor

The 68099 II Precise Impactor is an instrument used for traumatic brain injury and spinal cord injury model. The system adopts pneumatic-electric control, which can precisely adjust the speed, depth and dwell time to achieve precise impact. Touch screen design, convenient and friendly operation. The zero method uses a sensor contact mechanism to automatically detect the zero interface, which is sensitive and efficient.

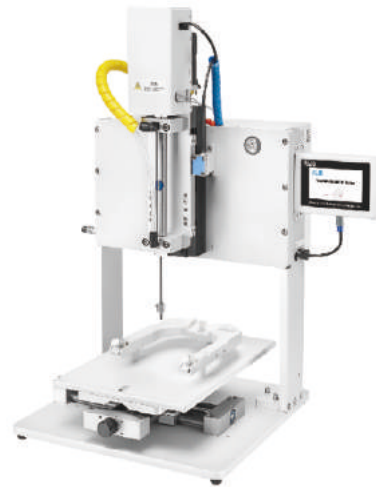

### Features:

- Pneumatic-electric design, stable blow without shaking, to ensure the repeatability of the experiment;
- It is suitable for small animal brain and spinal cord injury models such as mice, rats, and guinea pigs;
- LCD touch screen, wide-angle visibility, convenient and friendly operation;
- Sound alarms and text message prompts improve the human-computer interaction between the equipment and the user, and reduce human errors in the operation process;
- The zero-contact method can automatically determine the zero interface to reduce human error;
- A variety of cylindrical flat-head head hammers with outer diameters of 1, 2, 3, 4 and 5mm, which can meet the needs of traumatic brain injury and spinal cord injury model;
- Speed calibration function to ensure the stability and repeatability of the experiment;
- Speed range is 0.5-5.6m/s, resolution 0.1m/s; depth range is 0.00-5.00mm, resolution 0.01mm; dwell time range is 0.00-5.00s, resolution 0.01s;
- The rotatable design ensures that the brain and spinal cord are hit vertically and improves the repeatability of the experiment.

### Traumatic Brain Injury(TBI)

- Two kinds of brain adaptors for rats and mice are optional. The rotational adaptor can rotate left and right  $\pm 30^\circ$ , the height adjustment range of  $+10\sim-20\text{mm}$ , and the precise rotational adaptor can rotate left and right  $\pm 30^\circ$ , swing up and down  $\pm 10^\circ$ , three-axis displacement 30mm;
- The base is movable, 0~116mm in X direction and 0~98mm in Y direction.



Precise Rotational Adaptor

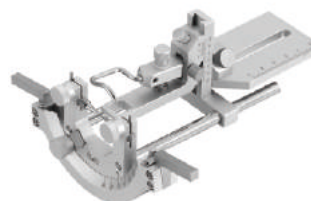

Rotational Adaptor



Head hammers

## Spinal Cord Injury(SCI)

- The rat and mouse spinal cord adaptor adopts the method of supporting the spinal cord from the lower sides of the spine to avoid the depth error caused by the collapse of the animal when breathing or impacting;
- The three-axis micro-manipulated rotatable platform includes a universal adjustment device, which can adjust the level of the spinal cord to ensure vertical strikes and improve experiment repeatability.

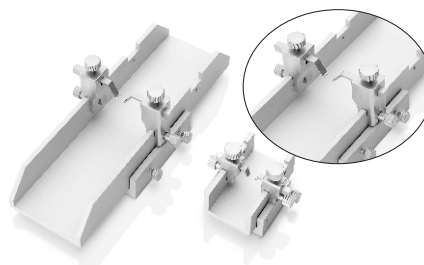

Spinal Cord Adaptor



Three-axis Micro-manipulated Rotatable Platform

### Order Information:

Model	Product Description	Remarks
68099 II	Precise Impactor-Brain	Standard configuration (without adaptor)
68099 II -S-M	Precise Spinal Impactor for Mice	Standard configuration (including adaptor)
68099 II -S-R	Precise Spinal Impactor for Rat	Standard configuration (including adaptor)
68063	Rotational Rat Adaptor, 60°Ear Bars Incl.	Optional
68065	Rotational Mouse Adaptor, 60°Ear Bars Incl.	Optional
69100-03	Precise Rotational adaptor for Rat	Optional, can fix the head of mouse collaborately use mouse anesthesia adaptor(69110 or 69111) and ear bars(69114).
69100-04	Precise Rotational adaptor for Mouse	Optional, can fix the head of rat collaborately use rat anesthesia adaptor(69112) and ear bars(69115).
69110	Mouse Anesthesia Adaptor with Tubing(<30g)	Optional (69100-04 including)
69111	Mouse Anesthesia Adaptor with Tubing(30~70g)	Optional
69112	Rat Anesthesia Adaptor with Tubing	Optional (69100-03 including)
69114	60°Ear Bars for Mouse, One pair	Optional (69100-04 including)
69115	18°Ear Bars for Rat, One pair	Optional (69100-03 including)



# Animal Anesthesia Machine

## Small Animal Anesthesia Machines ▶

### R500 Compact Anesthesia Machine

Regular assembly (R500-A), vaporizer (R580), Inlet/Outlet End Caps (R580-IO) and tube accessory kit are included in the R500 anesthesia machine. Different air supply, induction chambers, small animal masks, filter canisters and gas evacuation apparatuses can be selected for anesthesia recovery of different animals.

Suitable for rats, mice, hamsters, guinea pigs, rabbits, cats and other animals within 7kg

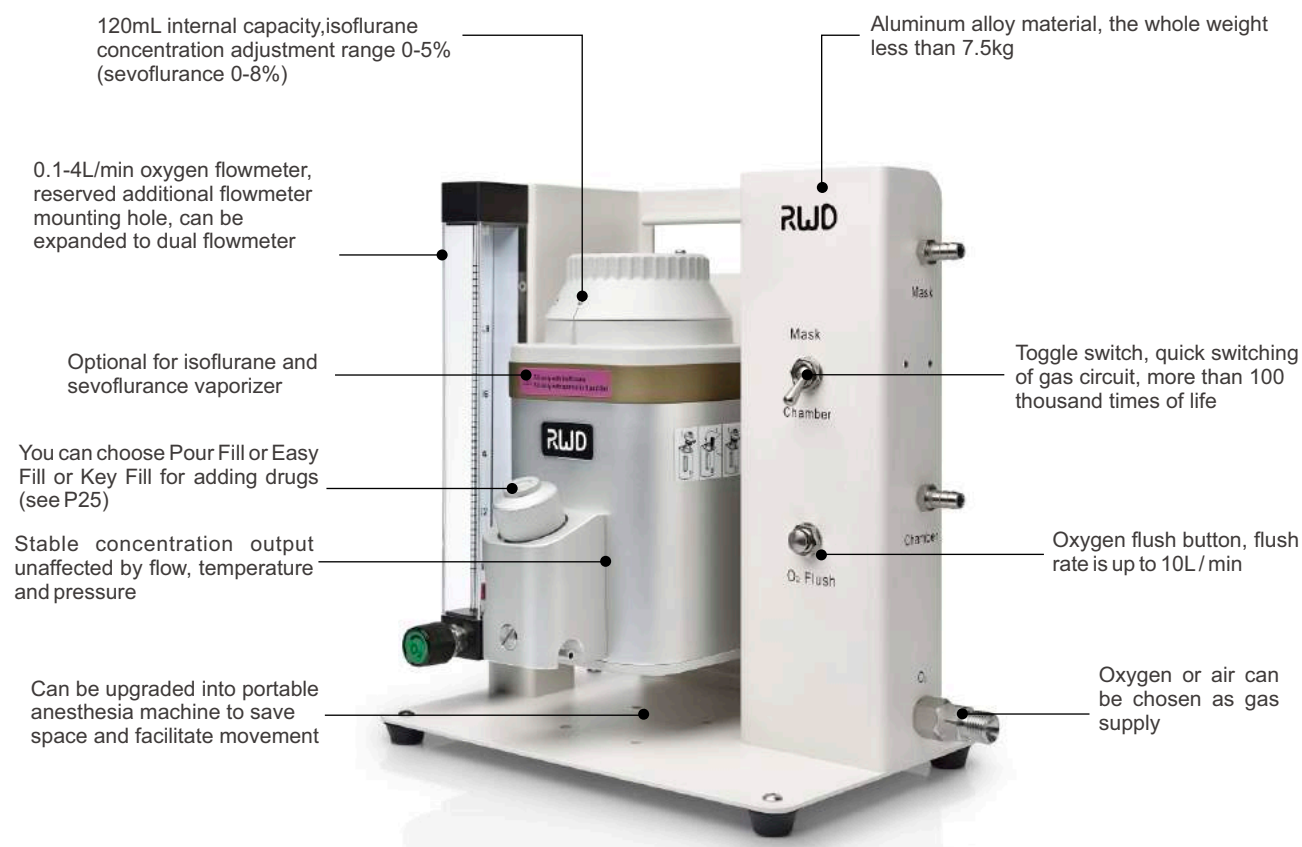

Note: Oxygen flush is commonly used to flush out anesthetic gas to the filter canister before opening the induction chamber to prevent the operators from anesthetic gas.

#### Order Information:

Model	Product Description	Configuration	Remarks
R500IE	Compact Small Animal Anesthesia Device-Isoflurane, Easy Fill, 0-4L	●	Contains connection tubing for mask&induction chamber
R500IP	Compact Small Animal Anesthesia Device-Isoflurane, Pour Fill, 0-4L	●	
R500IK	Compact Small Animal Anesthesia Device-Isoflurane, Key Fill, 0-4L	●	
R500SE	Compact Small Animal Anesthesia Device-Sevoflurane, Easy Fill, 0-4L	●	
R500SP	Compact Small Animal Anesthesia Device-Sevoflurane, Pour Fill, 0-4L	●	
R500SK	Compact Small Animal Anesthesia Device-Sevoflurane, Key Fill, 0-4L	●	
R510-S	Portable Stand for R510 Series Anesthesia Machine	○	Upgrade to portable type

Note: ●Recommended configuration ○ Optional

## R550 Multi-output Anesthesia Machine

Regular assembly (R550-A), vaporizer (R580), Inlet/Outlet End Caps (R580-IO) and tube accessory kit are included in the R550 anesthesia machine. Different air supply, induction chambers, small animal masks, filter canisters and gas evacuation apparatuses can be selected to form the experimental platform for anesthesia recovery of different animals.

With the latest design, it can be applies to simultaneous anesthesia of multiple mice, rats, cats, rabbits and other animals (1-5 small animals), and every channel can be controlled independently.

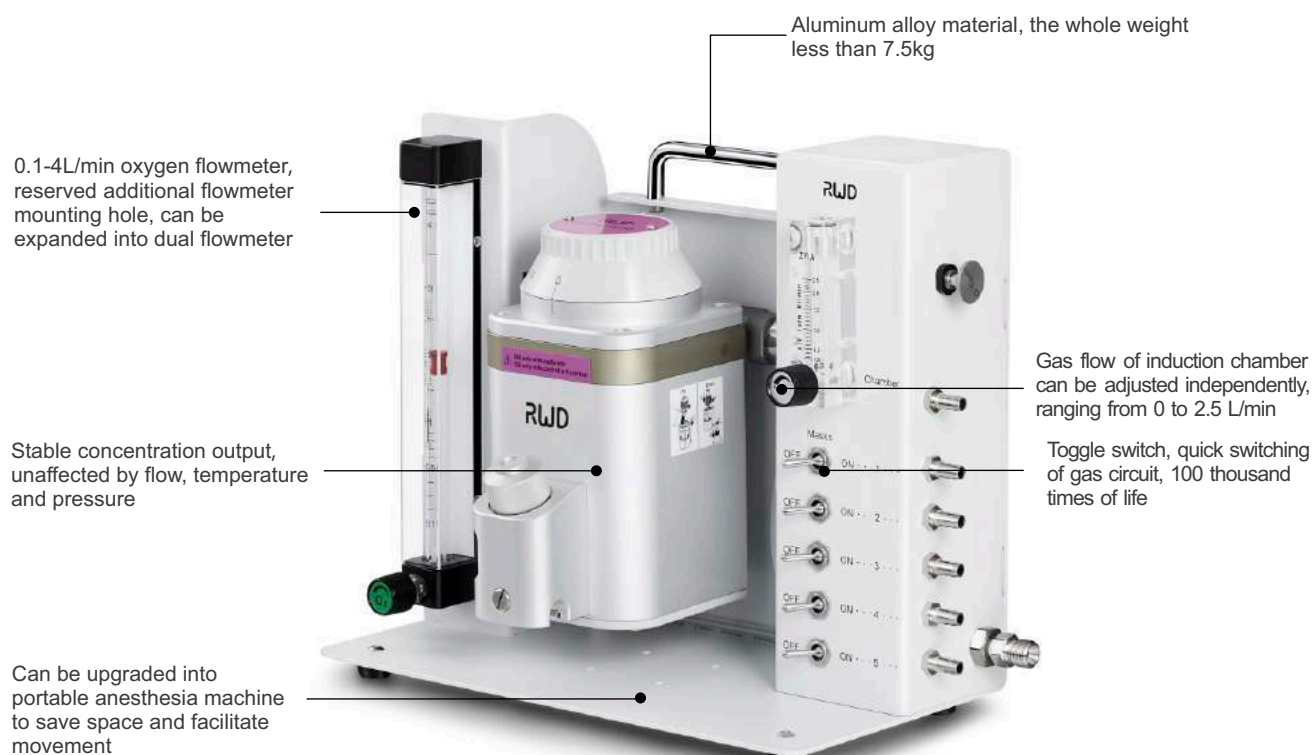

### Order Information:

Model	Product Description	Configuration	Remarks
R550IE	Enhanced Small Animal Anesthesia Device-Isoflurane, Easy Fill, 0-4L	●	Contains connection tubing for mask & induction chamber.
R550IP	Enhanced Small Animal Anesthesia Device-Isoflurane, Pour Fill, 0-4L	●	
R550IK	Enhanced Small Animal Anesthesia Device-Isoflurane, Key Fill, 0-4L	●	
R550SE	Enhanced Small Animal Anesthesia Device-Sevoflurane, Easy Fill, 0-4L	●	
R550SP	Enhanced Small Animal Anesthesia Device-Sevoflurane, Pour Fill, 0-4L	●	
R550SK	Compact Small Animal Anesthesia Device-Sevoflurane, Key Fill, 0-4L	●	
R510-S	Portable Stand for R510 Series Anesthesia Machine	○	Upgrade to portable type

Note: ●Recommended configuration ○ Optional

## R530 Portable Anesthesia Machine

Regular assembly (R540-A), vaporizer (R580), Inlet/Outlet End Caps (R580-IO), induction chamber, fixed bracket for gas evacuation apparatus, air pump, and portable assembly (R510-S), tubing are included in the R520 anesthesia machine. Different air supply, induction chambers, small animal masks, filter canisters and gas evacuation apparatus should be purchased separately. The difference between R520 & R530 is only the anesthesia assembly.

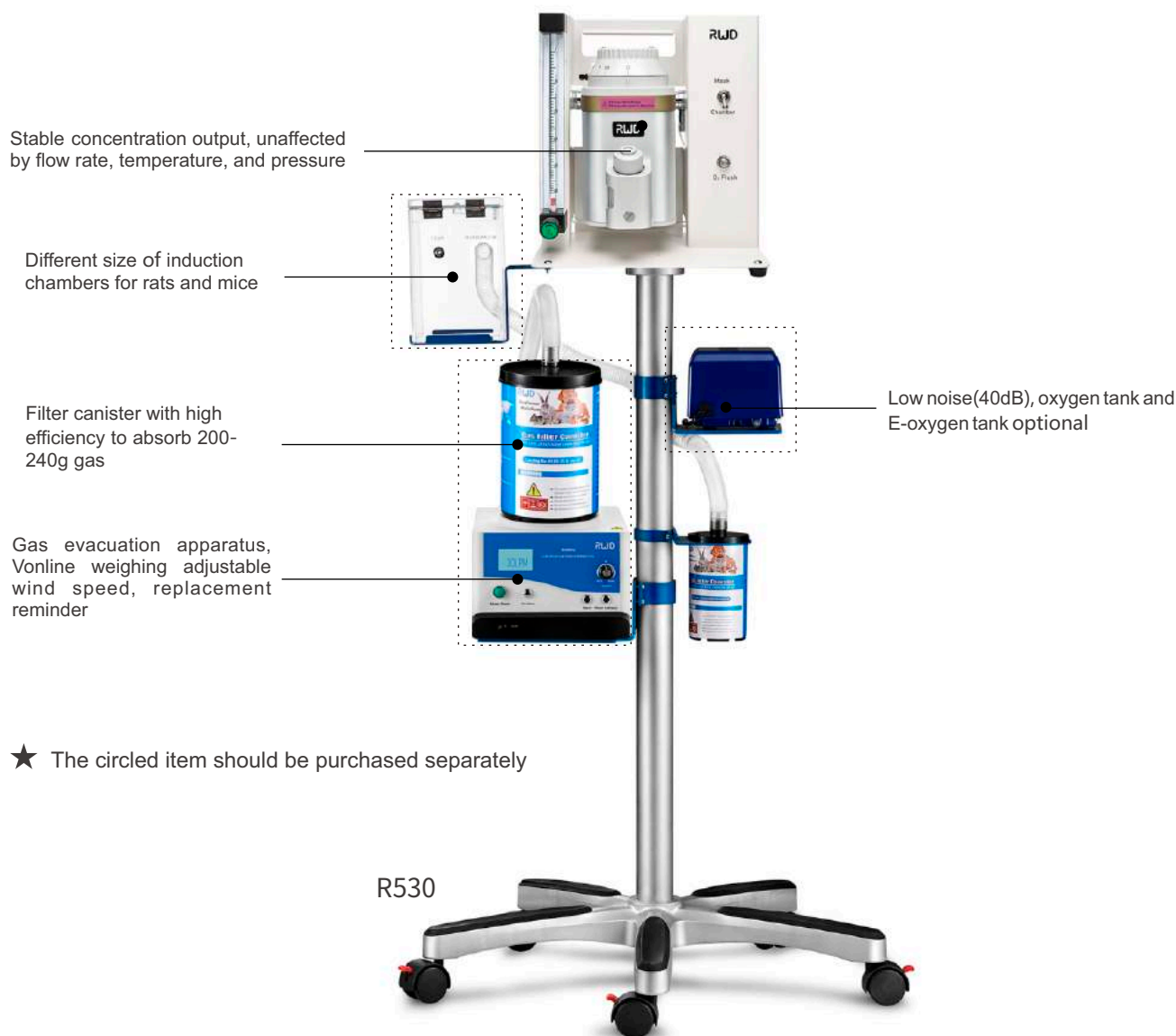

★ The circled item should be purchased separately

R530

### Order Information:

Model	Product Description	Configuration	Remarks
R530IE	Portable Anesthesia Machine, Isoflurane, Easy Fill, 0-4L	●	Including fixed bracket for induction chamber, evacuation apparatus, filter canister.
R530SE	Portable Anesthesia Machine, Sevoflurane, Easy Fill, 0-4L	●	

Note: ● Recommended configuration ○ Optional

## Veterinary Anesthesia Machines ▶

### R620-S1 Universal Veterinary Anesthesia Machine

R620-S1 universal veterinary anesthesia machine is applicable to clinical anesthesia of dogs, cats, pigs, monkeys, rodent, reptiles, birds etc. With "one-click" operation mode, it would be easy, safe and reliable to perform surgery on pets.

#### User-friendly design

Blocking bar design for breathing circuit, wheel brake for Universal wheel, and tray shelf for placing monitor

#### Rail-mounted CO<sub>2</sub> absorber

One step to assemble and disassemble, save time and effort to a great extent

#### Full inspection policy

Inspection would be made before shipment to make sure high accuracy

#### Minimal operation design

Just press to close APL valve; turn the switch to shift between rebreathing and non-rebreathing circuit; with only one action to install and uninstall the vaporizer; With one switch to turn, the smart weighing canister start to work

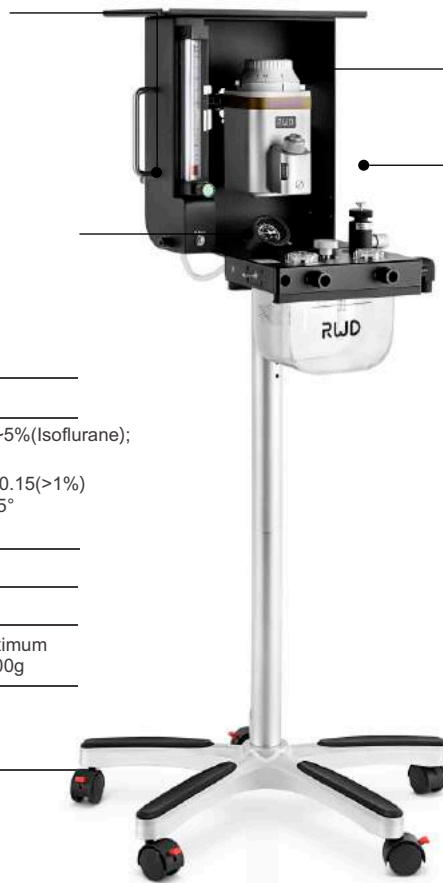

Item	Specification
Vaporizer	Output concentration: 0~5%(Isoflurane); 0~8%(Sevoflurane) Accuracy: ±0.1(0-1%); ±0.15(>1%) work temperature: 10~35° Volume>120ml
Flowmeter	0.1-4L/min
CO <sub>2</sub> Absorber	1.8L
Filter canister	Self-weight is 800g, Maximum absorption capacity is 200g
Weighing device	Alarm range>1000g (R510-31 filter canister); Resolution:1g

Optinal: MRI Conditional Animal Anesthesia Machine are available for purchase.

#### Order Information:

Model	Product Discription	Configuration	Remarks
R620-S1-IECS	Veterinary Anesthesia Machine-Pole Mount, Isoflurane, Easy Fill, Cagemount	●	Super package. Comparedwith the basic package, an additional oxygen valve,calcium lime,a trachea cannula hanger ,Mounting Braket for Weighing Meter, and an automatic Weighing Apparatus are included.
R620-S1-SECS	Veterinary Anesthesia Machine-Pole Mount, Sevoflurane, Easy Fill, Cagemount	●	
R620-S1-IECP	Veterinary Anesthesia Machine-Pole Mount, Isoflurane, Easy Fill, Cagemount	●	
R620-S1-SECP	Veterinary Anesthesia Machine-Pole Mount, Sevoflurane, Easy Fill, Cagemount	●	
R620-MRI	MRI Conditional Animal Anesthesia Machine	●	

Note: ● Recommended configuration ○ Optional

## Complete Anesthesia and Respiration Solutions ▶

### Multi-function Anesthesia Solutions



The experimental system is equipped with a gas recovery system to provide a safe experimental environment to maximize the protection of the operator; by replacing different types of anesthesia machines and masks to meet the needs of animal experiments, such as cerebral ischemia and myocardial ischemia model, osteoporosis model, tail vein injection, abdominal aorta blood sampling, heart blood sampling, ventricular injection, tissue / organ removal and other animal surgery experiments.

### Stereotaxic Anesthesia Solutions

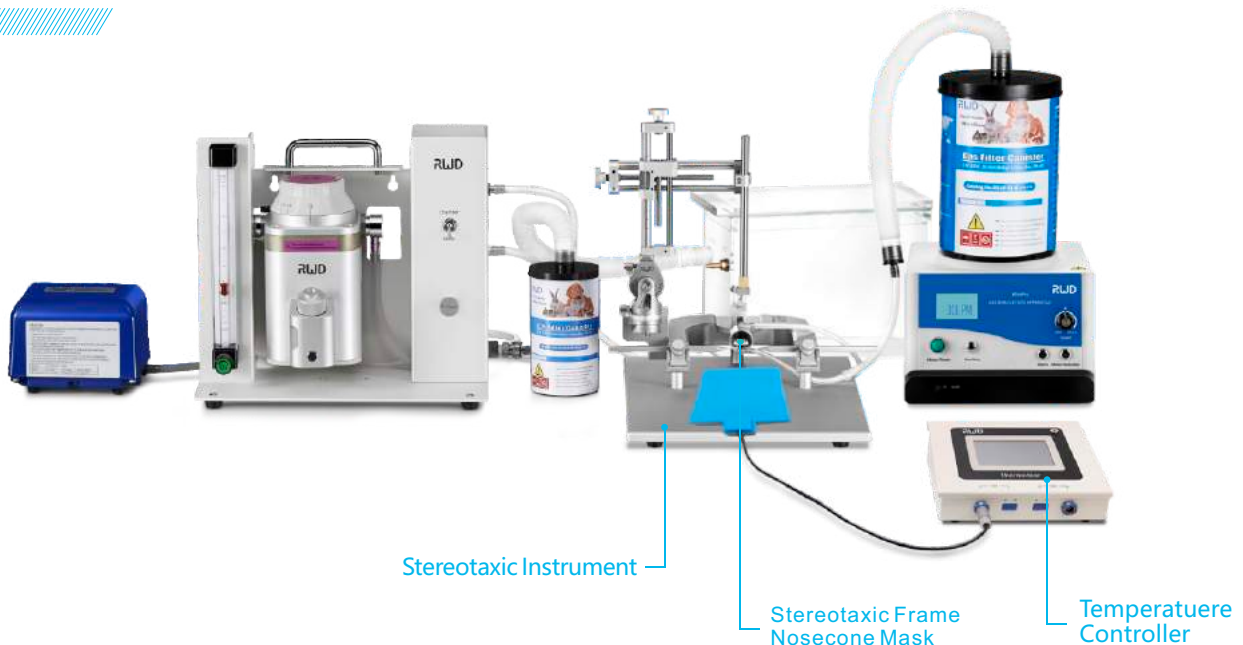

By changing the different types of stereotaxic instruments and adaptors to meet the needs of different animal experiments, such as the neurological disease models (such as Parkinson, Alzheimer's disease, craniocerebral injury, spinal cord injury, etc.), brain drug injection, Cannula Implantation (long term repeated administration), physiology experiment (such as nerve stimulation, signal recording, wireless telemetry, etc.), microdialysis experiments (probe implantation and short-term dialysis) and other experiments.

## Combination Solutions of Ventilator to Anesthesia System

### Small animals



Small animal ventilator

This program is the combination of anesthesia machine and ventilator. While keeping the animal under anesthesia, it provides a certain volume (tidal volume) of oxygen and respiratory rate to support the normal breathing of animals.

It can meet the requirements of long surgeries or surgeries on animals suffering from certain diseases (such as cardiovascular and cerebrovascular diseases, hypertension, cerebral infarction, thrombosis), it's suitable for mice, rats, rabbits, cats and other animals within 1kg.

### Large animals



Oxygen Concentrator



Circular anaesthetic mask



Laryngoscopes



Endotracheal Tubes



Calcium lime

This program is suitable for the anesthesia and auxiliary respiration of animals within 100kg, such as pigs, monkeys, dogs and cats.

## Anesthesia Machine Accessories ▶

### (Anesthesia Machine) Vaporizer

Adopted advanced design, R580 series vaporizer can be perfectly collaborated with small animal anesthesia machine and large animal anesthesia machine to make sure accurate transmission of anesthetic gas. RWD offers Pour Fill, Easy Fill and Key Fill Cagemont and Selectatec.

Two kinds of vaporizers  
Three dosing methods  
Two installation



Isoflurane vaporizer



Sevoflurane vaporizer



Pour-Fill



Easy-Fill



Key-Fill

#### Features:

- The built-in temperature compensator ensures the stable concentration of anesthetic gas at different temperatures and flow rates, the flow range is 0.2-10L/min.
- Mixed anesthetic gas output pressure range  $\Delta P \leq 2.5\text{kPa}$ .
- Applicable temperature range: 10-35 °C.
- Good tightness, internal 50kPa pressure can be maintained, zero leakage, safe and reliable.
- Internal capacity is not less than 120ml, and the range of isoflurane vaporizer concentration is 0-5% (Sevoflurane: 0-8%).
- Anti-accident open lock structure and closed state security protection structure to ensure safety.
- The average filling rate is greater than 2ml/s, and the dosing adapter can withstand the pressure of 0.1mpa without leakage (Key Fill).

Note:

When purchasing a Cagemont vaporizer, vaporizer endcaps (model: R580-IO) should be purchased separately.

Vaporizer of Easy Fill includes adapter R582-01 or R583-01.

Vaporizer of Key Fill includes adapter R584-01 or R585-01.

#### Order Information:

Cat No.	Product Description
R580S	Vaporizer - Isoflurane/Pour Fill/Cagemont
R581S	Vaporizer - Sevoflurane/Pour Fill/Cagemont
R582S	Vaporizer - Sevoflurane/Easy Fill/Cagemont
R583S	Vaporizer - Isoflurane/Easy Fill/Cagemont

Cat No.	Product Description
R584S	Vaporizer-Isoflurane/Key Fill/Cagemont
R585S	Vaporizer-Sevoflurane/Key Fill/Cagemont
R580-IO	Vaporizer Endcaps (1 pair)

### Isoflurane & Sevoflurane

#### Order Information:

Model	Product Description
R510-22-16	Isoflurane-100mL (16 bottles/box)
R510-22-8	Isoflurane-100mL (8 bottles/box)



Isoflurane

## Gas Evacuation Apparatus

The gas evacuation apparatus (GEA) was designed to safely and actively remove waste gas associated with everyday inhalation anesthesia. The waste gas from cone mask, concentric tubing mask and stereotaxic frame nosecone masks can be pulled through activated charcoal canister so that the air can be re-circulated into the room. The GEA will accommodate waste gas supply from at least 5 masks. The new one has been upgraded with a wider range of exhaust flow, Low noise, and Exquisite exterior design.

### Features:

- New design make it more exquisite and easy to carry.
- A wide range of flow rate-8~60LPM, real-time display through LED screen.
- Small size 232mm (W)\*200mm (D)\*184mm (H).
- Noise reduction system within 50dB. One click set mute to prevent noise.
- Two level overweight alarm: 990g and 1010g.
- Power: 100-240V, 50/60Hz.
- Automatic temperature compensation system can help stably run even in 5°C-40°C.
- Integrated negative pressure recovery system and weighing alarm functions, can weigh and display the weight of the gas filter tank at anytime to confirm whether the adsorption is saturated.



R546Pro

### Order Information:

Model	Product Description
R546Pro	Gas Evacuation Apparatus with Weight Monitoring, 110-240V

## Gas Filter Canister



Used to absorb isoflurane, sevoflurane and enflurane and other gases, disposable, large and small size are available, large canister (net weight: 800g) absorb 200-240g gas; small canister (net weight: 250g) absorb 50g gas.

### Order Information:

Model	Product Description
R510-31-6	Gas Filter Canister, Large, pkg of 6pcs
R510-31S-6	Gas Filter Canister, Small, pkg of 6pcs
R510-31S-16	Gas Filter Canister, Small, pkg of 16pcs

## Induction Chambers

The anesthetic gas is inducted into the chamber, and exhausted to the connected charcoal canister. With following features:

- Transparent plexiglass material, durable, easy to clean, convenient to observe the anesthetic state of animals.
- Positive pressure gaskets at lids.
- Both ports on one side to reduce tubing in procedure area.



### Order Information:

Model	Product Description	Remarks
V100	Induction Chamber-mouse (15cm*10cm*10cm)	Contains 1 plexiglass box, 1.2m bellows and 1 gas filter canister (R510-31S)
V101	Induction Chamber-rat (24cm*12cm*18cm)	
V102	Induction Chamber-rabbit/cat (40cm*18.5cm*25cm)	
V103	Induction Chamber-large animal (50cm*30cm*30cm)	



## Small Animal Anesthesia Mask

### • Concentric Tubing Masks

Using Concentric Tubing design, sturdy and durable, can be placed arbitrarily on the desktop. The entire mask (including tubing) is made of non-metallic material suitable for MRI environments.

- The mask can be secured by fixed bracket (68625), height of the mask is adjustable, and it can also be fixed and placed in MRI, PET and SPECT imaging systems.



### Order Information:

Model	Product Description
R510-86	SGL MRI Compatible Mask for Mouse
R510-88	Dual MRI Compatible Masks for Mouse
R510-54	Five-channel Tubing Anesthesia Mask Kits-rat/mouse

Model	Product Description
R510-87	SGL MRI Compatible Mask for Rat
R510-89	Dual MRI Compatible Masks for Rat
68625	MRI Compatible Mounting Bracket for Tubing or Cone Mask, optional

### • Cone Masks

- Special designed with inlet tubing inside make the animal anesthesia exhaust gas can be absorbed by gas filter canister.
- Allows access to eyes, ears and top of head.
- The cone masks can be installed onto 68630 operation bed for single cone mask (300\*210\*75mm) or 68657 manifold for five cone masks.

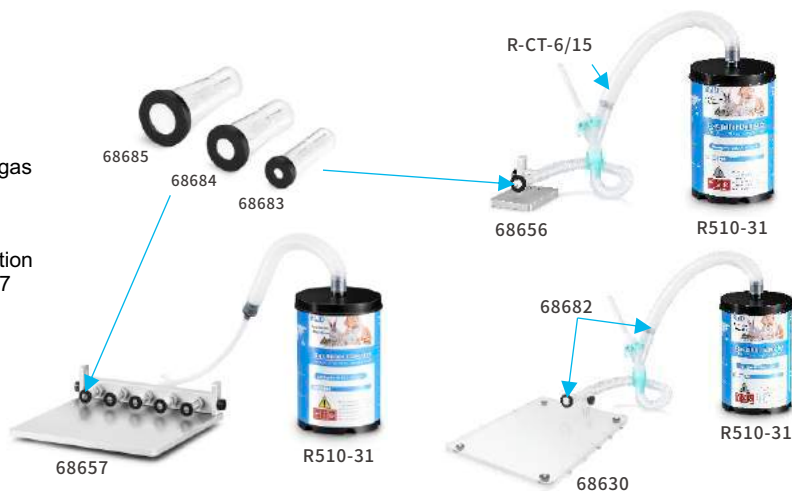

### Order Information:

Model	Product Description	O.D. (size)	I.D.(size)	D(size)	Nosecone Model
68680	Cone Mask with Tubing for Neonatal Mouse(<15g)	13mm	5mm	24mm	68683
68681	Cone Mask with Tubing for Mouse or Neonatal Rat(15-40g)	20mm	10mm	28.5mm	68684
68682	Cone Mask with Tubing for Rat(200-350g)	25mm	15mm	38mm	68685

Model	Product Description
R-CT-6/15	Concentric Tubing, 6mm Inlet/15mm Outlet, 45cm
68656	Manifold for Single Cone Mask

Model	Product Description
68657	Manifold for Five Cone Masks
68630	Anesthesia Operation Platform

# Animal Ventilator

## VentStar Small Animal Ventilator

Animal ventilator is the most commonly used equipment to assist animal respiration. It is widely used in basic medicine, clinical medicine, animal medicine and other scientific research experiments (such as myocardial ischemia model making, lung function evaluation), respiratory management, animal first aid and respiratory treatment in clinical surgery. Small animal ventilator suitable for 10g-1kg mice, rats and guinea pigs and other small animal.

Suitable for mice, rats and guinea pigs and other animals weighing 10g-1kg

Input power range: 100 ~ 240V, 50/60Hz, 24V, 40W, 1.67A adapter DC power supply, safe and effective

Small size, compact layout, flexible operation

Provide safe and effective intermittent positive pressure ventilation (IPPV), volume and pressure modes are available.

7 inches LCD touch screen, wide-angle visual

The pressure-time graph can be displayed in real time in volume and pressure modes

Sound, intelligent text, error code and other fault alarm alerts

10 groups of different respiratory parameters can be stored and called, which is convenient and efficient

R415-AP

Set the respiratory parameters such as PIP/PEEP/Sigh/INSP.Hold/EXP.Hold

The breathing frequency can be switched between 10 ~ 300bpm

Tidal volume range: 0.05ml ~ 5ml

After submitting the animal weight, and the device automatically sets the reference breathing parameters

Airway pressure range: 1~50cmH<sub>2</sub>O, the accuracy range: ±0.7 cmH<sub>2</sub>O; positive end expiratory pressure (PEEP) range is 0~10cmH<sub>2</sub>O

The adjustable range of I:E ratio is from 20% to 80%; the sigh increases the tidal volume from 0 to 20%, and can set auto-sigh once after every 10 to 999 breaths or manual control

Model	Product Description
R415	Small Animal Ventilator
R415-AP	Accessory package for Anesthesia and Ventilator

## RE20 Animal Endotracheal Intubation Kit

Noninvasive endotracheal intubation kit for animals guided by cordless optic fiber to support mouse, rat and other similar small rodents in a stable and comfortable position for experimenters to perform endotracheal intubation, drug infusion and other operations, effectively reducing animal damage, and enhancing the experimental efficiency and precision of the experiment results.

### Features:

- PU material, moderate soft and hard, comfortable and not harmful to animals;
- The cordless portable optic fiber lighting system, which has been patented for an invention, improves the visibility of the airway and facilitates users to quickly and accurately finish endotracheal intubation;
- The stand angle can be adjusted, including: 45°, 60°, 90°, to meet the requirements of users with different operation habits;
- An endotracheal magnifier with auxiliary positioning function and a tracheoscope mirror that helps to confirm intubation result are more user-friendly.



### Order Information:

Model	Product Description
RE20-R	Endotracheal intubation tube for rat (length 50mm)
RE20-M	Endotracheal intubation tube for mouse (length 25mm)

## R419 Intelligent Animal Ventilator

R419 intelligent animal ventilator as mechanical ventilation device, which is completely according with veterinary clinical practice. There are 3 modes of operation, including VCV, PIPCV and APNEA, to meet multiple clinical applications.

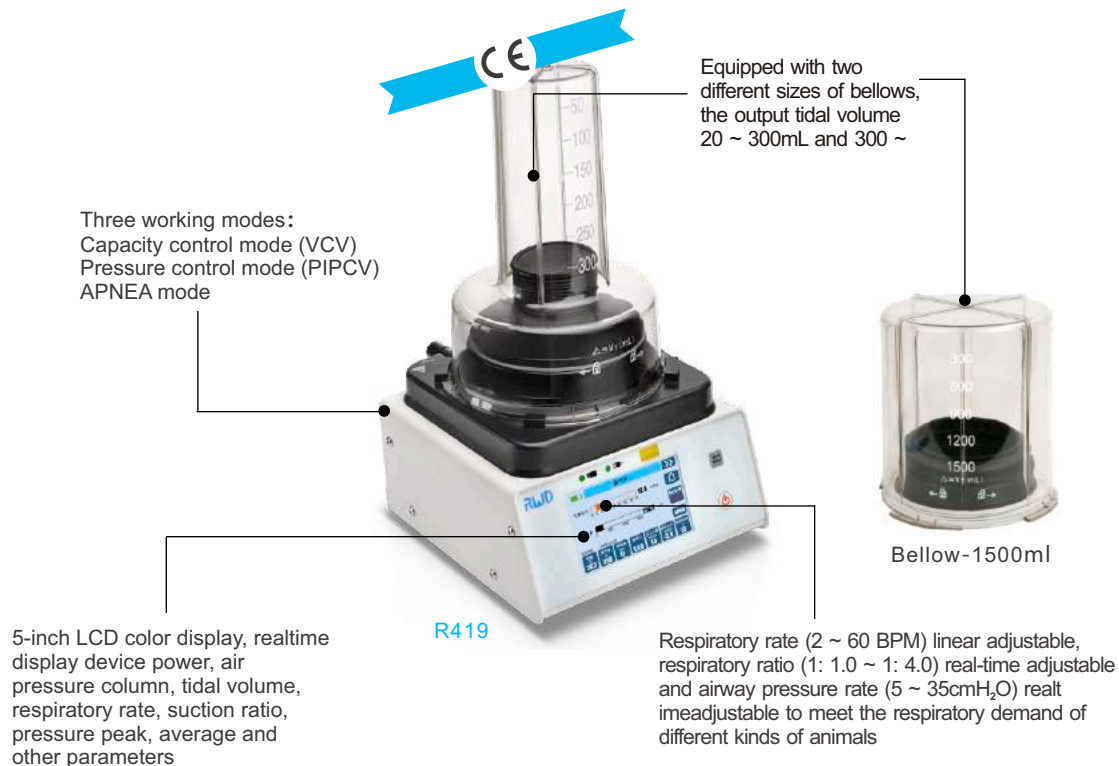

### Order Information:

Model	Product Description
R419	R419 Intelligent animal ventilator
R409-MB	Mounting Bracket for R409 Ventilator

- Adjustable power supply (110 / 220V)
- Light weight, portable, user-friendly design, multi-parameter fixed platform, easy to operate
- Provides safe and effective intermittent positive pressure ventilation (IPPV)
- Provide internal battery power, which can work more than 4 hours

## Surgical Auxiliary Equipment

### DOM-1001 Digital Microscope

DOM-1001 is a digital microscope without eyepiece, with dual light sources and a cross arm bracket. High-end optical components and 16 million pixel CMOS camera can be used to capture real-time images and video, realizing multi-person sharing. Mainly used in life science, university teaching, industrial manufacturing, material science and other fields.

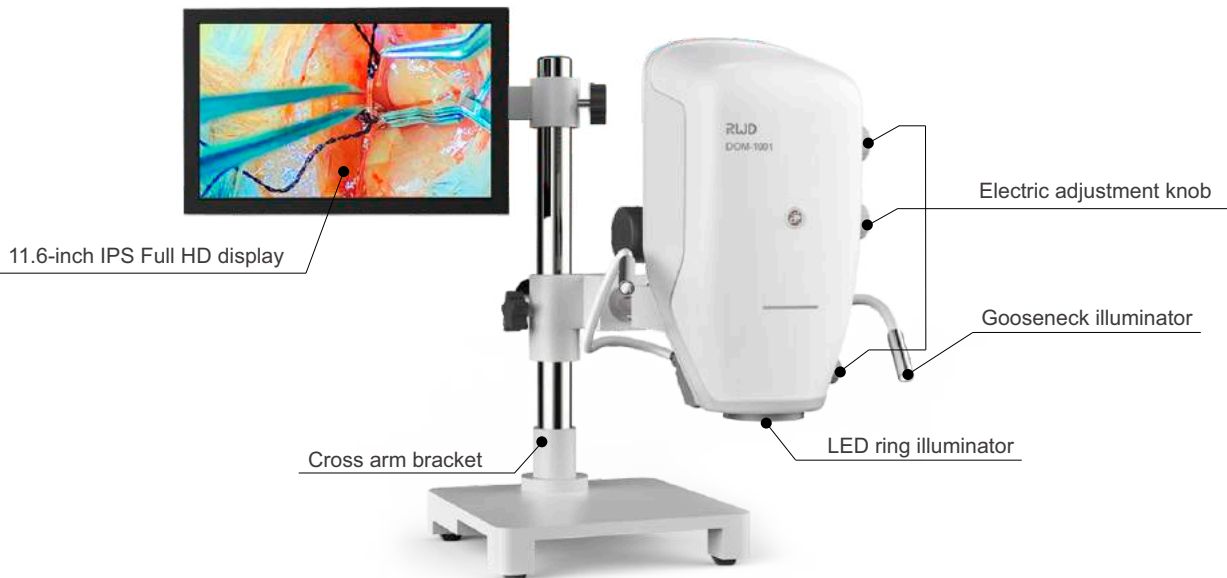

#### Features:

- **Novel and unique integrated design**

High-end optical components and a 16 million pixels digital camera, combined with LED ring lights and gooseneck light control components, and optional brackets for various scenarios, together create a powerful DOM-1001 digital surgical microscope system.

- **Excellent ergonomic design**

The comfortable electric adjustment knob on the side is combined with the foot focus adjustment, and with the 11.6-inch display, the operator can maintain a correct and comfortable working posture, reducing fatigue and damage caused by long-term use.

- **Real-time ultra high-definition projection screen**

Built-in digital camera with zoom optical components, high depth of field (maximum depth of field 6.7mm), adjustable magnification 8-44X(11.6-inch display), 18-100X(27-inch display), support real-time display with high-definition monitor or notebook computer connection.

- **Convenient and practical remote control**

With the infrared remote control, you can directly perform remote control, including many functions such as taking pictures, recording videos, flipping and zooming, adjusting brightness and contrast of images, and white balance.

- **Homogeneous and coaxial optical design**

Always displayed in the center of the field of view in a clear and optimal state-no need to refocus even when changing the magnification.

- **Greater operating space**

The working distance of 180 mm, the lens body can be adjusted at multiple angles, which greatly improves the operating space and ensures that observation and operation are performed simultaneously.

## Microscope

77001S Desktop Binocular Stereo Microscope equips with universal support; researchers can observe in high resolution and three-dimension.

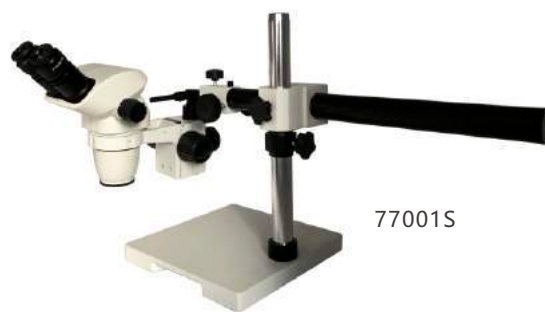

77001S

### Features:

NO.	Products Name	Products Detail
1	Eyepiece	10X Eyepieces, View field diameter $\phi$ 22mm
2	Objective Lens	0.67X-4.5X Objective lens ratio 1:6.7
3	Binocular Drawtube	Pupil Distance 55-77mm Diopter adjustment $\pm$ 5 ,Diopter 45°Incline 360°Spin
4	View field Range	31.2 mm -5.1mm
5	Total Magnification	6.7X-45X(10X Eyepiece),3.35X-22.5X(10X Eyepiece +0.5X Assist lens)
6	Working Distance	Working distance 105mm(10X Eyepiece),Working distance 177mm (10X Eyepiece +0.5X Assist lens)
7	Focusing Mechanism	Focusing hand wheel is adjustable
8	Universal Support	360°Spin, Retractable
9	Lighting	TY-B-2 Ring LED Illumination

On the basis of the binocular microscope, 77008S Trinocular Zoom Stereo microscope increase the interface, so that the camera, video camera can be installed in the microscope to achieve real time observing of the objects.



77008S

## 77002 Vertical Animal Operating Microscope

The vertical animal operating microscope is a simple operating microscope with single person and binocular coaxial illumination. The body is small and light with high flexibility, which can meet the requirements of general animal microsurgery.

### Features:

- Eyepiece magnification: 12.5x, objective lens focal length: 200 mm.
- Working distance: 190mm, main mirror magnification: 5.3x, 8x, 12x.
- Field of view diameter: 38mm, 25mm, 17mm.
- The adjustment range of diopter:  $\pm$  5D, the adjustment range of pupil distance: 50mm-70mm.
- Lighting source: 12V / 100W, cold reflection medical halogen bulb.
- Lighting type: 6° + 0° cold source coaxial lighting.
- Illumination of coaxial lighting surface:  $\geq$  20000 LX, transverse arm extension radius: 870 mm.
- Vertical adjustment range (ground to large objective): 700mm-1100mm, fine focus stroke: 30mm.
- Voltage: AC220 V  $\pm$  10%, 50 Hz  $\pm$  1 Hz, power: 120 VA.
- Fuse: AC250V T1.25A weight: 41kg.



77002

## Animal Restrainer

### Tubular type Restrainer

Tubular type restrainer is used to restrict the animal from turning or moving, by fixation on rear-end and flexibly regulated. Unique design of tapered nose restrainer provide easy-access for animals, meanwhile makes animals feel safety.

Taper restrainer is a new fixed tool design for animal injection, suitable for fast and efficient batch injection.

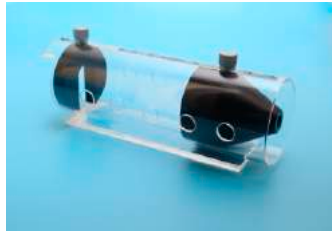

Restrainer



Taper restrainer

### Ordering Information:

Model	Products Description
9131	Small restrainer for up to 15g Mouse/L110xI.D.20mm
9132	Medium restrainer for 15-40g Mouse/L135xI.D.30mm
9133	Large restrainer for 50-75g Mouse/L160xI.D.40mm
9134	Small restrainer for 75-200g Rat/L200xI.D.50mm
9135	Medium restrainer for 200-300g Rat/L210xI.D.60mm
9136	Large restrainer for 300-500g Rat/L220xI.D.70mm
9137	Extra Large restrainer for above 500g Rat/L230xI.D.80mm
9138	Taper restrainer for Mice/L150xH130xO.D.100mm

## Rats & Mice Shaver

### Features:

- Applicable to shave off hair on animals' cephalosome, face, legs and ear.
- AA batteries use.
- Low vibration and noise as well as ergonomic design.
- Suitable for small animals.

CP-5200



## Manual Syringe Pumps (68606)

Compatible with RWD stereotaxic instruments, simple installation, with 10µm displacement accuracy and up to 25mm distance, it is an economical and practical microinjection pump!

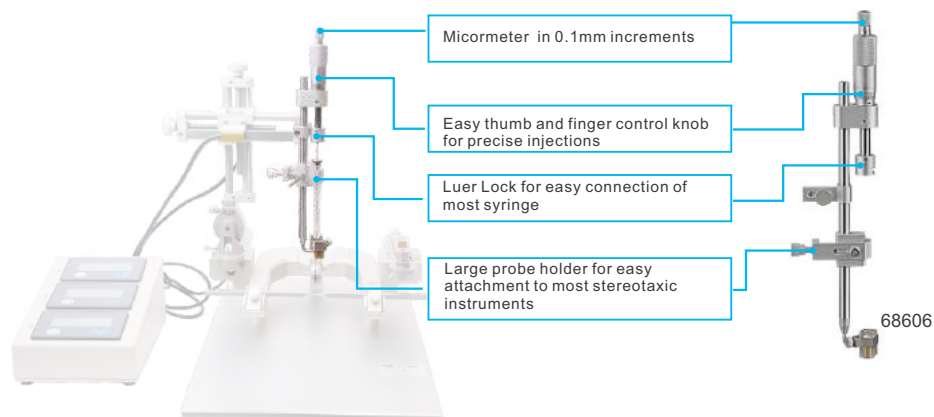

### Features:

- Precisely-controlled infusion/withdrawal of picoliter volume.
- Provides an economical means of injecting or withdrawing a calibrated volume with simple, precise manual control.
- The injector has a universal adaptor for all RWD and Hamilton 700, 7000 or Gas-Tight Series syringers, ranging from 1 to 100µl sizes and enables a wide range of volumes to be delivered-both infusion and withdrawal operation.
- The Manual Stereotaxic injector is graduated in 0.01mm increments. One complete revolution advances the plunger of the syring 0.5mm.

## Cordless Microdrill

It is battery-powered, easy to carry and space-saving.

### Features:

- Cordless design, simple & controllable operation.
- The double-bearing design is used at the joint of the drill bit, make drilling and grinding more stable.
- 750mA lithium battery, can be used continuously for 45 mins after fully charged.
- Wide range of applications, can be used with a 2.3mm diameter drill bit for drilling and polishing.
- It can be equipped with a cranial drill holder (68228) fixed to Stereotaxic, free hands operation.
- Speed: 12000rpm.
- Stall torque: 1.25 oz./in.
- Power: 100-240V.
- Dimension: length 20cm, body diameter 19.5mm .



### Order Information:

Model	Product Description
87001	Cordless Microdrill (Bits Not Included, some details see below)
68228	Cordless Microdrill Holder(Holds the microdrill with diameter about 19.5mm.)

## Microdrill

It takes only one second to drill the skull, easy to operate and control. It can also be used for grinding the skull.



### Features:

- Speed up to 38,000rpm.
- Forward or reverse available.
- Controlled manually or by foot pedal.
- Can be installed onto the stereotaxic instrument by the microdrill holder (Model: 68605) and controlled by the manipulator.
- Various drill bits available, diameter from 0.5-2.3mm.

### Order Information:

Cat No.	Product Description	Cat No.	Product Description
78001	Microdrill (bits not included)	78050	Drill Bits HM1027 2.7mm, Round Tip, pkg of 2
78040	Drill Bits HM1005 0.5mm, Round Tip, pkg of 5	78060	Drill Bits HM31008 0.8mm, Flat Tip, pkg of 5
78041	Drill Bits HM1006 0.6mm, Round Tip, pkg of 5	78061	Drill Bits HM31010 1.0mm, Flat Tip, pkg of 5
78042	Drill Bits HM1008 0.8mm, Round Tip, pkg of 5	78062	Drill Bits HM31012 1.2mm, Flat Tip, pkg of 5
78043	Drill Bits HM1010 1.0mm, Round Tip, pkg of 5	78063	Drill Bits HM31014 1.4mm, Flat Tip, pkg of 5
78044	Drill Bits HM1012 1.2mm, Round Tip, pkg of 5	78064	Drill Bits HM31016 1.6mm, Flat Tip, pkg of 5
78045	Drill Bits HM1014 1.4mm, Round Tip, pkg of 5	78065	Drill Bits HM31018 1.8mm, Flat Tip, pkg of 5
78046	Drill Bits HM1016 1.6mm, Round Tip, pkg of 5	78066	Drill Bits HM31021 2.1mm, Flat Tip, pkg of 5
78047	Drill Bits HM1018 1.8mm, Round Tip, pkg of 5	78067	Drill Bits HM31023 2.3mm, Flat Tip, pkg of 5
78048	Drill Bits HM1021 2.1mm, Round Tip, pkg of 5	68605	Microdrill Holder
78049	Drill Bits HM1023 2.3mm, Round Tip, pkg of 5		

## Fiber-lite Illuminator

The halogen fiber-lite illuminator adopts dual-piple pipe optic coaxial lighting, provide better field of view, with good brightness; stable output voltage, safe and reliable light bulb; size is about 280 x, 100 x 165mm, and the light intensity can be adjusted continuously , with color temperature 3200K.



Halogen fiber-lite illuminator

### Order Information:

Model	Product Description	Remarks
76301	Fiber-Lite Illuminator(150W)	Dual-Pipe Fiber Optic, Bulb and Main Engine
76304	Main Engine	
76310	Dual-Pipe Fiber Optic(Included in illuminator)	
76306	Replacement Bulb for 76301 Illuminator (21V 150W) -OSRAM	

## ThermoStar Homeothermic Monitoring System

During the process of animal surgery or acute anesthetized animal experiment, maintaining animals' body temperature is very important for the accuracy and reliability of results, furthermore, it is an important way to reduce the mortality of the animals. In order to fulfill this need, RWD launched a new generation of homothermic monitoring system "Thermostar", the control unit acquired a 4.3 inch color LCD touch screen, allows users to clearly view the subject's real-time body temperature, set the target temperature, view the heating state and set audible alarms when subject's body temperature turns abnormal. A specific control separate circuit for heating pad and rectal probe, respectively to ensure the stability and safety of the system.



heating pad (69023 / 69024 / 69025)



temperature probe (69022)

### Features:

- Real-time display of the working status of the heating pad, and monitor the working state of every channel, show: IDLE, WARNING, STANDBY, and WORKING.
- Heating range: 20-45°C, 0.1°C resolution, Degrees Celsius and Fahrenheit can be switched.
- Power supply: 100-240V, 50/60Hz.
- Control unit size: L205 x W148 x H80 mm.
- Control unit weight: 1.3kg.

### Order Information:

Type	Model	Product Description	Remarks
Complete system	69020	ThermoStar Temperature Controller, 69023 pad incl.	A heating pad (69023) and a temperature probe (69022) incl.
	69026	ThermoStar Temperature Controller, 69024 pad incl.	A heating pad (69024) and a temperature probe (69022) incl.
	69027	ThermoStar Temperature Controller, 69025 pad incl.	A heating pad (69025) and a temperature probe (69022) incl.
Temperature probe	69022	Temperature Probe	1.5mm diameter, 30mm rod length, the length of the probe is 150cm.
Heating pad	69023	Heating Pad-12.0*20.5cm	the length of heating pad is 150cm.
	69024	Heating Pad-9.0*17.0cm	
	69025	Heating Pad-7.0*10.0cm	



## RLT-24 Veterinary Laser Therapy

RLT-24 Veterinary Laser Therapy is non-invasive, deep penetrating, painless and without side effects, and can be used for recalcitrant wounds, chronic diabetic ulcers, neurological injuries. It can be used in the study of diseases such as intractable injuries, chronic diabetic ulcers, neurological damage and inflammatory pain.



### Features:

- Intelligence Solutions: more than 1,300 recommended treatment built in, it can be adjusted according to the specific experiment.
- Multiple modes: support three laser emission modes: CW mode, Pulse mode and ISP mode. The combination of multiple modes can improve the treatment efficiency, reduce thermal burns, and intensify laser treatment.
- High power: the laser power is up to 24W, with remarkable treatment effect, stable light, safe and fast.
- Four wavelengths: arbitrary combination of four wavelength lasers of 650nm, 810nm, 915nm and 980nm, different wavelengths of laser can be selected for different experiments.
- User-friendly design: LCD touch screen; the rear-mounted large optical fibre winding disk, which is convenient for storage and protects the optical fibre and prolongs its service life.
- Features: built-in video tutorial board, "hands-on" teaching, and no difficulty in operation; automatic storage of treatment records for easy information traceability.

### Order Information:

Cat No.	Description
RLT-24	Veterinary Laser Therapy

### Included:

Description	Amount	Function	Remarks
Veterinary Laser Therapy	1	Laser therapy	Included
Optical fibre handpiece	1	Laser transmission and control	
Lens	5	Change the beam size to realize optimal treatment and diversity	
Protective goggles	6	3 for staff and 3 for animals for eyes protection	
Interlock	1	The interlock should be connected to the device to prevent any personnel entering the room and being exposed to the laser irradiation	
Power adaptor	1	Device power input	
Toolkit	1	Store lens and optical fibre handpiece	

## R-CU600 Smart Animal ICU

R-CU600 The Smart Animal ICU, provides animal patients with the most comfortable medical care environment to help animals recover faster. It is suitable for postoperative recovery, emergency care of critical animals, delivery, infant care, respiratory diseases, aging diseases, animal atomization therapy and other animal diseases treatment.



### Features:

- **Smart parameters:** a variety of model animal parameters are built in the system, which can be selected according to the actual needs of the experiment;
- **Touch screen operation:** high definition 7-inch touch screen, intuitive, parameters at a glance;
- **Trebling purification function:** air filter / UV sterilization system /high concentration negative ion environmental, avoid cross infection of animals;
- **Multiple alarm:** the system covers temperature and humidity, CO<sub>2</sub> concentration, sensor failure, heating failure and other abnormal alarms;
- **Digital control:** inner wall wrapped 3D temperature control system, heating balance; Independent external humidifier, stable performance, convenient injection; Sensitive infrared probe, accurate monitoring of CO<sub>2</sub> concentration;
- **Satisfy a variety of experimental conditions:** infusion / oxygen supply / atomization therapy.

### Order Information:

Model	Product Description
R-CU600	Smart Animal ICU

## Surgical Instruments & Matrix

RWD surgical instruments and Matrices products cover more than 10 types of instruments and consumables such as surgical scissors, clamps, forceps, auxiliary instruments, sterilizers, molds, sutures. There are thousands of specifications as well offer well-equipped surgical kits which could satisfied with all kind of animal modeling experiment. More details please refer to the catalog from page 66 to 81, or visit our web: [www.rwdstco.com](http://www.rwdstco.com).

### The surgical kits included:

Surgical instrument kit for MCAO, spinal cord injury, universal dissecting, cardio-cerebral perfusion surgery, brain micro injection surgery and micro dialysis surgery etc. which could satisfied with the whole experiment operation for rodents from skin dissection to sutured.



### Surgical scissors included:

Micro spring scissors, delicate scissors, surgical scissors, dissecting scissors, boon cutters and ophthalmic scissors etc. which could satisfied with different experiment requirement of tissues dissecting, cutting, and separate.

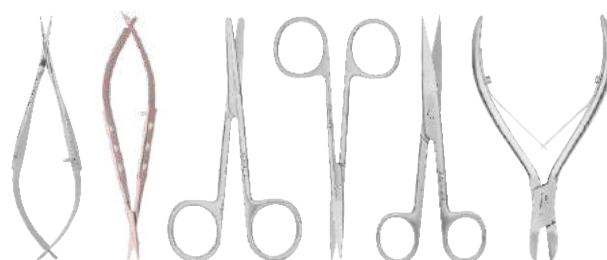

### Surgical forceps included:

Tissue forceps, hemostatic forceps, needle holder and bone rongeurs etc. which could satisfied with the requirement of tissues clamping, fixation, hemostasis, stitich and bone trimming and cutting.

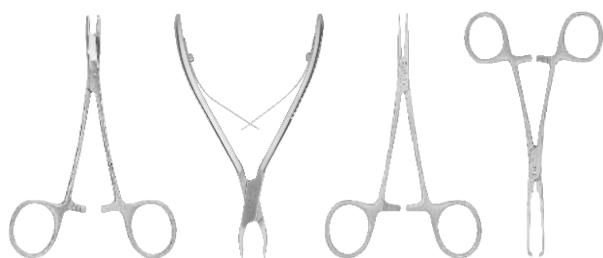

### Surgical forceps included:

Micro forceps, tissue forceps and dressing forceps and ophthalmic forceps etc. it is mainly used for the clamping and separation of soft tissues such as blood vessels, nerves, organs, skin etc.

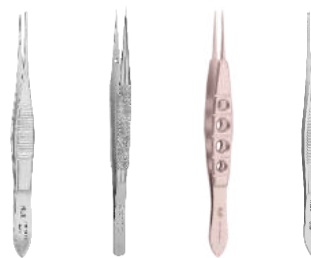

### Auxiliary instruments such as:

Scalpel, retractors, hooks, blood vessel clamps, sutures <with needle>, sterilization box and marking instrument etc. to meet the requirement of skin dissection.



### The matrices included:

Brain and hear matrix, stainless material offered solid and durable quality which could be heated, cooled, autoclaved and scrubbed for long time using. Sterilizer mainly used for Instruments' high temperature sterilization with high efficiency. MCAO sutures made of Silica gel wrapped nylon thread material which could easily enter the common carotid artery and embolize the middle cerebral artery without puncturing the inner wall of the vessel, which greatly improves the success rate and repeatability of the modeling.



# Neural Signal Regulation Solution

## Optogenetics System

Optogenetics uses light-responsive proteins to control biological processes. The unmatched spatiotemporal precision, high tunability, reversibility, and few side effects of light makes optogenetics a powerful strategy to study neuroscience and complex biological systems. RWD new intelligent optogenetics system, on the basis of the last generation machines (laser and waveform generator integrated into one), has made another leap in the performance.

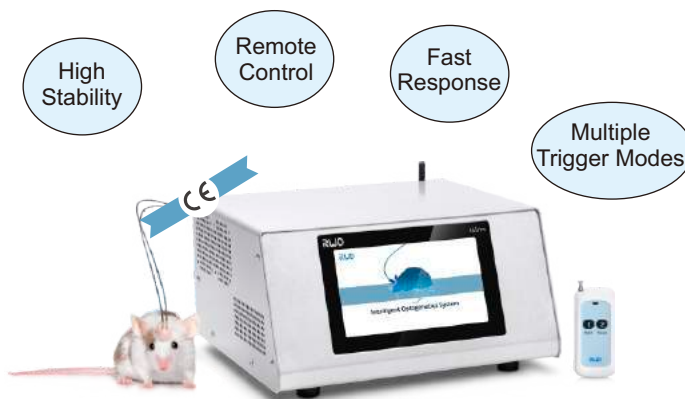

### Features:

- Built-in CW(continuous wave)mode, one-button power test.
- The test/experiment mode can be switched with one key, and the test power value can be directly written into the experiment program.
- Equipped with a remote control, which can control multiple optogenetics devices simultaneously within a range of ten meters.
- Three external trigger modes: Edge/Real-time/Gate, to meet more experimental requirements.

**Edge mode1:** If the trigger voltage is higher than or equal to the set value of trigger voltage, the program will run; the trigger is only featured by the "on" function and the program's duration depends on its set duration.

**Real-time mode2:** If the trigger voltage is higher than or equal to the set value of the trigger voltage, the program will run; if it is lower than that value, the program will stop; the trigger is characterized by the "on/off " function. The duration of the program depends on the duration of the trigger.

**Gate mode3:** The running power relies on the first subprogram selected and other parameters are defined by the external device, and only response to the square wave with frequencies  $\leq 500\text{Hz}$  .

- High resolution signal processing, external signal delay  $<1\text{ms}$ .
- High stability, long-term operation power fluctuation is less than 1%.
- Support program group custom editing, import and export, experimental programs and records can be exported externally to review.
- With signal input/output interface, it can be compatible with electrophysiology, fiber photometry system, behavioral instruments and other equipment.

### Software Interface:



Parameter Setting Interface

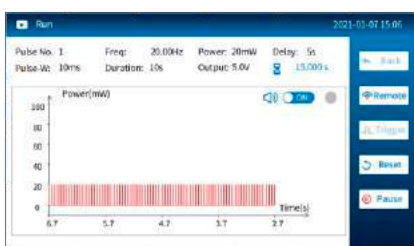

Program Running Interface



Trigger Interface

## Technical Parameters:

Parameter item	Specification
Power	1-100mW, 1mW resolution
Operation mode	Remote control/touch screen/external trigger
Input	2V-10V
Output	10mV-5V
Safety	Password; High temperature alarm; Program run prompt
Storage	Internal memory/USB flash disk

## Order Information:

Model	Product Description
IOS-465	Intelligent Optogenetics System(465nm)
IOS-589	Intelligent Optogenetics System(589nm)

## Patchcord and Optical Fiber

- Low insertion loss • Good repeatability • High return loss • Stable temperature
- Good mutual insertion performance • Optional fiber
- Applicable wavelength: 400nm-1100nm • Numerical aperture: 0.22, 0.39, 0.50
- Default length is 1m, other length: 1.5-5m, step 0.5m (customized)
- Core diameter: 100 $\mu$ m, 200 $\mu$ m, 300 $\mu$ m, 400 $\mu$ m

## Order Information:

Model	Product Description
R-FC-PC-N2-100-L1	FC/PC Optical Fiber Patch Cables(m) - 100 $\mu$ m, 0.22NA, 1m
R-FC-PC-N2-200-L1	FC/PC Optical Fiber Patch Cables(m) - 200 $\mu$ m, 0.22NA, 1m
R-FC-PC-N2-300-L1	FC/PC Optical Fiber Patch Cables(m) - 300 $\mu$ m, 0.22NA, 1m
R-FC-PC-N2-400-L1	FC/PC Optical Fiber Patch Cables(m) - 400 $\mu$ m, 0.22NA, 1m
R-FC-PC-N3-200-L1	FC/PC Optical Fiber Patch Cables(m) - 200 $\mu$ m, 0.39NA, 1m
R-FC-PC-N3-300-L1	FC/PC Optical Fiber Patch Cables(m) - 300 $\mu$ m, 0.39NA, 1m
R-FC-PC-N3-400-L1	FC/PC Optical Fiber Patch Cables(m) - 400 $\mu$ m, 0.39NA, 1m
R-FC-PC-N5-200-L1	FC/PC Optical Fiber Patch Cables(m) - 200 $\mu$ m, 0.50NA, 1m
R-FC-PC-N5-400-L1	FC/PC Optical Fiber Patch Cables(m) - 400 $\mu$ m, 0.50NA, 1m
R-FC-L-N2-100-L1	Optic Fiber(m), FC/PC Adapter with $\Phi$ 1.25 mm Ceramic Ferrule, 100 $\mu$ m Core, 0.22NA, 1m
R-FC-L-N2-200-L1	Optic Fiber(m), FC/PC Adapter with $\Phi$ 1.25 mm Ceramic Ferrule, 200 $\mu$ m Core, 0.22NA, 1m
R-FC-L-N2-300-L1	Optic Fiber(m), FC/PC Adapter with $\Phi$ 1.25 mm Ceramic Ferrule, 300 $\mu$ m Core, 0.22NA, 1m
R-FC-L-N2-400-L1	Optic Fiber(m), FC/PC Adapter with $\Phi$ 1.25 mm Ceramic Ferrule, 400 $\mu$ m Core, 0.22NA, 1m
R-FC-P-N2-100-L1	Optic Fiber(m), FC/PC Adapter with $\Phi$ 2.5 mm Ceramic Ferrule, 100 $\mu$ m Core, 0.22NA, 1m
R-FC-P-N2-200-L1	Optic Fiber(m), FC/PC Adapter with $\Phi$ 2.5 mm Ceramic Ferrule, 200 $\mu$ m Core, 0.22NA, 1m
R-FC-P-N2-300-L1	Optic Fiber(m), FC/PC Adapter with $\Phi$ 2.5 mm Ceramic Ferrule, 300 $\mu$ m Core, 0.22NA, 1m
R-FC-P-N2-400-L1	Optic Fiber(m), FC/PC Adapter with $\Phi$ 2.5 mm Ceramic Ferrule, 400 $\mu$ m Core, 0.22NA, 1m
R-FC-L-N3-200-L1	Optic Fiber(m), FC/PC Adapter with $\Phi$ 1.25 mm Ceramic Ferrule, 200 $\mu$ m Core, 0.39NA, 1m
R-FC-L-N3-300-L1	Optic Fiber(m), FC/PC Adapter with $\Phi$ 1.25 mm Ceramic Ferrule, 300 $\mu$ m Core, 0.39NA, 1m
R-FC-L-N3-400-L1	Optic Fiber(m), FC/PC Adapter with $\Phi$ 1.25 mm Ceramic Ferrule, 400 $\mu$ m Core, 0.39NA, 1m
R-FC-P-N3-200-L1	Optic Fiber(m), FC/PC Adapter with $\Phi$ 2.5 mm Ceramic Ferrule, 200 $\mu$ m Core, 0.39NA, 1m
R-FC-P-N3-300-L1	Optic Fiber(m), FC/PC Adapter with $\Phi$ 2.5 mm Ceramic Ferrule, 300 $\mu$ m Core, 0.39NA, 1m
R-FC-P-N3-400-L1	Optic Fiber(m), FC/PC Adapter with $\Phi$ 2.5 mm Ceramic Ferrule, 400 $\mu$ m Core, 0.39NA, 1m
R-FC-L-N5-200-L1	Optic Fiber(m), FC/PC Adapter with $\Phi$ 1.25 mm Ceramic Ferrule, 200 $\mu$ m Core, 0.50NA, 1m
R-FC-L-N5-400-L1	Optic Fiber(m), FC/PC Adapter with $\Phi$ 1.25 mm Ceramic Ferrule, 400 $\mu$ m Core, 0.50NA, 1m
R-FC-P-N5-200-L1	Optic Fiber(m), FC/PC Adapter with $\Phi$ 2.5 mm Ceramic Ferrule, 200 $\mu$ m Core, 0.50NA, 1m
R-FC-P-N5-400-L1	Optic Fiber(m), FC/PC Adapter with $\Phi$ 2.5 mm Ceramic Ferrule, 400 $\mu$ m Core, 0.50NA, 1m



Patchcord



Optical Fiber

## Fiber Optic Rotary Joint



Applicable to long time stimulation and observation experiments on awake and free moving animals, avoids twining of the fiber optic.

## Order Information:

Model	Product Description
R-FC-1x1	FC-FC Optic Fiber Commutator

## Ceramic Ferrule

### Features:

- Material: Ceramic, Optical fiber
- Type: White Series/Black Series
- Applicable wavelength: 400-2200nm
- Core diameter: 100µm, 200µm, 300µm, 400µm
- Numerical aperture: 0.22, 0.39, 0.50
- Outer diameter: 1.25mm (6.4mm long), 2.5mm (10.5mm long)
- Optical fiber length: 2mm-25mm (Ø1.25mm), 2mm-20mm (Ø2.5mm), step 0.5mm (Other lengths can be customized)

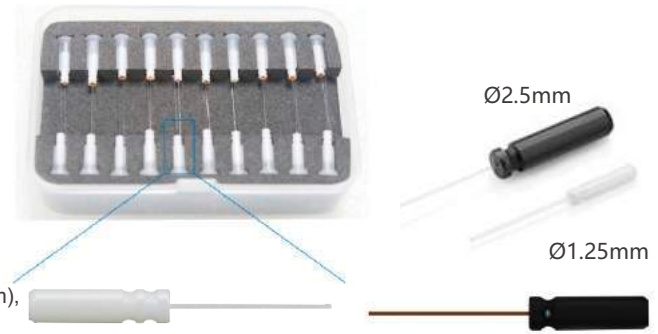

### Order Information:

No.	Model	Product Description
1	R-FOC-L200C-39NA	Fiber Optic Cannulae with Φ1.25 mm Ceramic Ferrule, 200um Core, 0.39NA, 20/pkg
2	R-FOC-L300C-39NA	Fiber Optic Cannulae with Φ1.25 mm Ceramic Ferrule, 300um Core, 0.39NA, 20/pkg
3	R-FOC-L400C-39NA	Fiber Optic Cannulae with Φ1.25 mm Ceramic Ferrule, 400um Core, 0.39NA, 20/pkg
4	R-FOC-F200C-39NA	Fiber Optic Cannulae with Φ2.5 mm Ceramic Ferrule, 200um Core, 0.39NA, 20/pkg
5	R-FOC-F300C-39NA	Fiber Optic Cannulae with Φ2.5 mm Ceramic Ferrule, 300um Core, 0.39NA, 20/pkg
6	R-FOC-F400C-39NA	Fiber Optic Cannulae with Φ2.5 mm Ceramic Ferrule, 400um Core, 0.39NA, 20/pkg
7	R-FOC-L200C-22NA	Fiber Optic Cannulae with Φ1.25 mm Ceramic Ferrule, 200um Core, 0.22NA, 20/pkg
8	R-FOC-L300C-22NA	Fiber Optic Cannulae with Φ1.25 mm Ceramic Ferrule, 300um Core, 0.22NA, 20/pkg
9	R-FOC-L400C-22NA	Fiber Optic Cannulae with Φ1.25 mm Ceramic Ferrule, 400um Core, 0.22NA, 20/pkg
10	R-FOC-F200C-22NA	Fiber Optic Cannulae with Φ2.5 mm Ceramic Ferrule, 200um Core, 0.22NA, 20/pkg
11	R-FOC-F300C-22NA	Fiber Optic Cannulae with Φ2.5 mm Ceramic Ferrule, 300um Core, 0.22NA, 20/pkg
12	R-FOC-F400C-22NA	Fiber Optic Cannulae with Φ2.5 mm Ceramic Ferrule, 400um Core, 0.22NA, 20/pkg
13	R-FOC-L200C-50NA	Fiber Optic Cannulae with Φ1.25 mm Ceramic Ferrule, 200um Core, 0.50NA, 20/pkg
14	R-FOC-F200C-50NA	Fiber Optic Cannulae with Φ2.5 mm Ceramic Ferrule, 200um Core, 0.50NA, 20/pkg
15	R-FOC-L400C-50NA	Fiber Optic Cannulae with Φ1.25 mm Ceramic Ferrule, 400um Core, 0.50NA, 20/pkg
16	R-FOC-F400C-50NA	Fiber Optic Cannulae with Φ2.5 mm Ceramic Ferrule, 400um Core, 0.50NA, 20/pkg
17	R-FOC-BL200C-39NA	Fiber Optic Cannulae(Black) with Φ1.25 mm Ceramic Ferrule, 200um Core, 0.39NA, 20/pkg
18	R-FOC-BL300C-39NA	Fiber Optic Cannulae(Black) with Φ1.25 mm Ceramic Ferrule, 300um Core, 0.39NA, 20/pkg
19	R-FOC-BL400C-39NA	Fiber Optic Cannulae (Black)with Φ1.25 mm Ceramic Ferrule, 400um Core, 0.39NA, 20/pkg
20	R-FOC-BF200C-39NA	Fiber Optic Cannulae (Black)with Φ2.5 mm Ceramic Ferrule, 200um Core, 0.39NA, 20/pkg
21	R-FOC-BF300C-39NA	Fiber Optic Cannulae (Black)with Φ2.5 mm Ceramic Ferrule, 300um Core, 0.39NA, 20/pkg
22	R-FOC-BF400C-39NA	Fiber Optic Cannulae (Black)with Φ2.5 mm Ceramic Ferrule, 400um Core, 0.39NA, 20/pkg
23	R-FOC-BL100C-22NA	Fiber Optic Cannulae (Black, yellow nylon coating)with Φ1.25 mm Ceramic Ferrule, 100um Core, 0.22NA, 20/pkg
24	R-FOC-BL200C-22NA	Fiber Optic Cannulae (Black, yellow nylon coating)with Φ1.25 mm Ceramic Ferrule, 200um Core, 0.22NA, 20/pkg
25	R-FOC-BL300C-22NA	Fiber Optic Cannulae (Black, yellow nylon coating)with Φ1.25 mm Ceramic Ferrule, 300um Core, 0.22NA, 20/pkg
26	R-FOC-BL400C-22NA	Fiber Optic Cannulae (Black, yellow nylon coating)with Φ1.25 mm Ceramic Ferrule, 400um Core, 0.22NA, 20/pkg
27	R-FOC-BF100C-22NA	Fiber Optic Cannulae (Black, yellow nylon coating)with Φ2.5 mm Ceramic Ferrule, 100um Core, 0.22NA, 20/pkg
28	R-FOC-BF200C-22NA	Fiber Optic Cannulae (Black, yellow nylon coating)with Φ2.5 mm Ceramic Ferrule, 200um Core, 0.22NA, 20/pkg
29	R-FOC-BF300C-22NA	Fiber Optic Cannulae (Black, yellow nylon coating)with Φ2.5 mm Ceramic Ferrule, 300um Core, 0.22NA, 20/pkg
30	R-FOC-BF400C-22NA	Fiber Optic Cannulae (Black, yellow nylon coating)with Φ2.5 mm Ceramic Ferrule, 400um Core, 0.22NA, 20/pkg
31	R-FOC-BL200C-50NA	Fiber Optic Cannulae (Black)with Φ1.25 mm Ceramic Ferrule, 200um Core, 0.50NA, 20/pkg
32	R-FOC-BF200C-50NA	Fiber Optic Cannulae (Black)with Φ2.5 mm Ceramic Ferrule, 200um Core, 0.50NA, 20/pkg
33	R-FOC-BL400C-50NA	Fiber Optic Cannulae (Black)with Φ1.25 mm Ceramic Ferrule, 400um Core, 0.50NA, 20/pkg
34	R-FOC-BF400C-50NA	Fiber Optic Cannulae (Black)with Φ2.5 mm Ceramic Ferrule, 400um Core, 0.50NA, 20/pkg

Notes: The above white series specifications can be customized to black.

## Ceramic Cannula & Ceramic Ferrules Protective Cap



Ceramic Cannula



Ceramic Ferrules Protective Cap

### Order Information:

Model	Product Description
R-MS-1.25	Ceramic Sleeves, Φ1.25mm (20pcs/ pkg)
R-MS-2.5	Ceramic Sleeves, Φ2.5mm (20pcs/ pkg)
R-BMS-1.25	Black Ceramic Sleeves, Φ1.25mm (20pcs/ pkg)
R-BMS-2.5	Black Ceramic Sleeves, Φ2.5mm (20pcs/ pkg)
R-DC-2.5	FC/PC Ceramic Ferrules Protective Cap- Φ2.50mm (200pcs/pkg)
R-DC-1.25	LC/PC Ceramic Ferrules Protective Cap- Φ1.25mm (200pcs/pkg)

## Fiber Tongs

- Suitable for 100µm-800µm fiber for stripping fiber coating



R-OFT-600

## Fiber Photometry System ▶

### R810 Dual Color Multichannel Fiber Photometry System

The fiber photometry system records changes in the intensity of fluorescence of neurons in specific brain regions to characterize changes in the activity of neuronal populations. The fiber photometry system can detect population neurons in free-moving animals for long periods of time, which is helpful to explore the correlation between neuron activity and animal behavior. R810 Dual Color Multichannel Fiber Photometry System has two excitation light sources(410nm and 470nm). The 410nm light source can be used to reflect the background noise signal, thus ensuring the acquisition of true fluorescence data. The system can acquire data from no less than 9 channels simultaneously and is suitable for simultaneous recording of multiple brain regions or multiple animals.



#### Features:

##### Convenient and Efficient

- Simply adjust the knob to ensure fiber focus
- The software integrates data acquisition, analysis and data plotting modules
- With a variety of acquisition methods and start & end setting conditions

##### Feature-Rich Extensions

- 4 Input and 4 Output interface for easy connection with other equipment such as optogenetics and electrophysiology for the closed-loop study of stimulation and recording
- Equipped with electrophysiological grounding interface to avoid interference when used in conjunction with electrophysiological experiments
- The software can synchronize and mark multiple special behavioral events or external input signals during the experiment
- The whole system includes the behavior camera, and the software integrates the behavior recording module, which can record the animal movement trajectory and the duration of the ROI area, and supports TTL signal output

##### Data Visualization

- Preview mode facilitates real-time adjustment of parameter settings according to pre-experiment
- Real-time display of signal markers allows direct observation of signal changes
- The analysis results can be exported to CSV, Heat-map, dff/f, Z-Score and other chart formats.

##### High Sensitivity

- Highly sensitive CMOS camera, high frame rate of 300FPS, high quantum conversion efficiency  $\geq 80\%$ , low noise, high gain
- Equipped with photobleaching apparatus to reduce the interference of autofluorescence of accessories

Parameter item	Specification
Frame Rate of CMOS	0~300FPS
CMOS resolution	2048*2048px~256*256px
Exposure time setting range	1~100 ms
Fluorescence band	500-535nm
LED power adjustable percentage	0~100%
410nm LED Output Power Range	0~100 $\mu$ W
470nm LED Output Power Range	0~100 $\mu$ W

## Tricolor Multichannel Fiber Photometry System



The system is equipped with laptop(include pre-installed software), low autofluorescence optical fiber, behavior camera, behavior camera bracket.



It can support up to 9 channels for simultaneous collection, which is suitable for simultaneous recording of multiple nerve nuclei or simultaneous recording of multiple animals.

Dual-camera fluorescence acquisition, signal interference-free, exposure time: 1-100ms; gain multiple: 1-100; frame rate of CMOS: 0-300FPS.

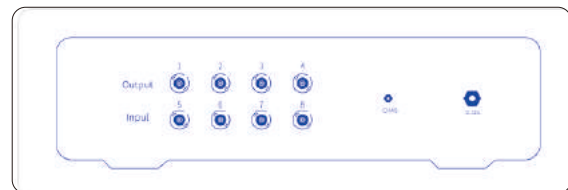
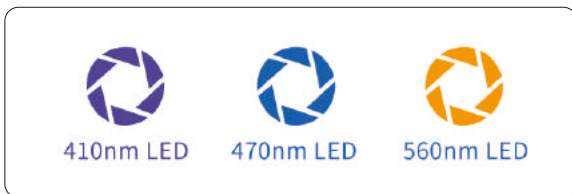

The excitation light source consists of 3 wavelengths of light (410nm,470nm,560nm), which can simultaneously record 2 ranges of excitation light (500 - 535nm, 575 - 628nm) — from the excitation of green fluorescent proteins (e.g. GCaMP) and red fluorescent proteins (e.g. RCaMP). 410nm can reflect the background noise signal.

4 Input interfaces are configured to support 4 kinds of external signal Input automatic markers; 4 Output interfaces, supporting output TTL signal to trigger external third-party equipment, to meet the closed-loop research.

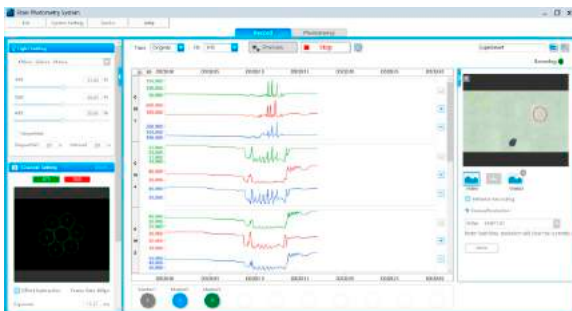

The system is equipped with fluorescence data acquisition and analysis software, and the software integrates the behavior record analysis module, which can realize the animal tracking automatic marking.



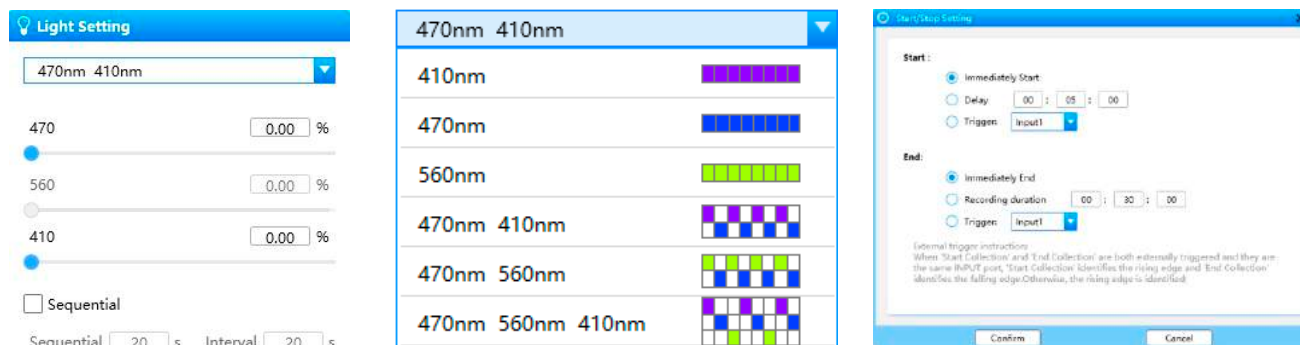

- The software presets 6 kinds of fluorescence excitation output modes, which can be used in different experimental application scenarios.
- The excitation light power can be directly adjusted on the operating software, the adjustment range is 0~100%, the adjustment precision is 0.1 $\mu$ W.

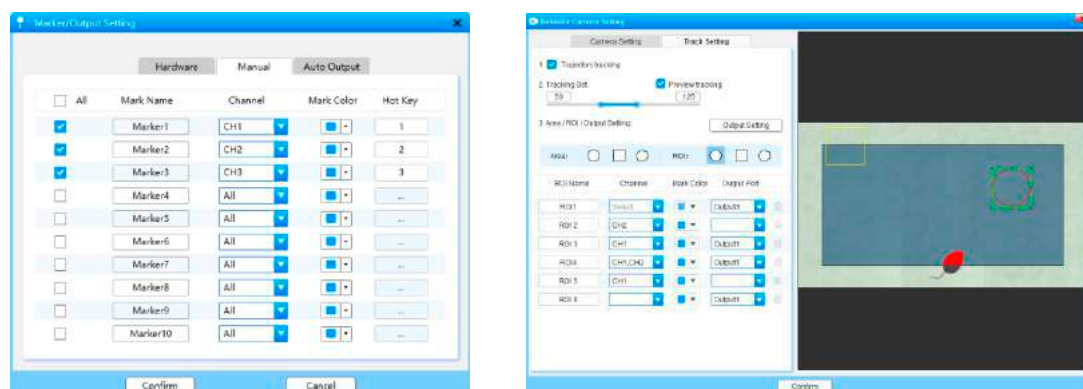

- The software has three marking functions, external marker, manual marker, automatic output marker. And it supports setting 10 markers at the same time.
- The acquisition stage can output TTL signal to trigger external devices when the fluorescence signal is greater than the set  $\Delta F/F$  threshold or when the animal enters a certain ROI area.

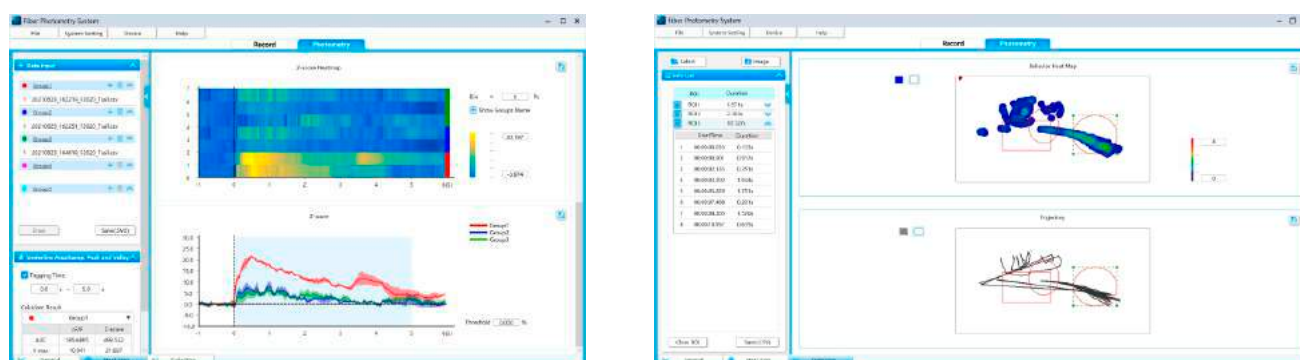

Equipped with special software—contains signal acquisition records, data analysis, behavioral video acquisition and analysis functions. The software includes the following analysis functions:

- ① The data can be smoothed, baseline correction, motion correction, view and output the processing process;
- ② Flexible selection and addition of event markers;
- ③ One-click analysis to generate heat maps and mean  $\pm$  sem;
- ④ Effective peak statistical analysis, AUC analysis;
- ⑤ Behavioral data can be analyzed trajectories and generate heat maps;
- ⑥ Analysis results can be exported to CSV, Heat-map, df/f, Z-Score and other formats.

## Micropipette Puller ▶

### MP-500 Micropipette Puller

RWD MP-500 micropipette puller is developed to solve the microelectrode problems in patch clamp and microinjection experiments. It has avant-garde intelligent operation interface, unique fixed position design of the heating filament and other user-friendly design. MP-500 integrates stability, intelligence and humanization, which can meet the requirements of microelectrode-related experiments and enhance user experience at the same time. In summary, MP-500 is an excellent choice for microelectrode related experiments.



#### Four Highlights:

Unique fixed position design of the heating filament,  
The integrated plug-in humidity control chamber,  
Full-color capacitor bilingual operation interface,  
The pulling of micropipettes is stable and efficient

#### Features:

- The unique fixed position design of the heating filament makes it easier to replace various models of filaments.
- The user interface adopts capacitive color touch screen (1024\*600px) with high sensitivity.
- The integrated plug-in humidity control chamber is easy to disassemble, which can keep the air around the filament and the capillary glass dry during the pulling process to avoid the adverse effect of humid air on the pulling result.
- Two microelectrodes with symmetrical tips are stably produced every time. The tip diameter can be less than 0.1  $\mu\text{m}$ , the taper length 3~15 mm, and the impedance range from 1 to above 100 $\Omega$  with high repeatability.
- According to the type of the capillary glass tube and the heating filament and the kinds of glass microelectrodes to be pulled (patch clamp microelectrodes, intracellular recording microelectrodes, etc.), the corresponding pull protocols are provided as a reference and can be modified according to special requirements.
- The device can store up to 99 pulling programs.
- The system diagnostic function can be used to manually check whether all the components of the puller are in normal working condition.
- The preheat mode can reduce the influence of the accumulation of jaw heat on the consistency of the pulling results during continuous pulling.
- The safe heat mode can avoid the damage of the filament from high temperature.
- The front panel cover adopts a roller design, which is convenient for users to open easily.

#### Order Information:

Model of micropipette puller	Product Description
MP-500 (HF-3025B)	Users can choose one of the three kinds of commonly used heating filament according to actual needs. One has already been installed on the puller before leaving the factory, and the other one is for replacement. In addition, we will add an additional filament that can be used for different types of experiments.
MP-500 (HF-3030B)	
MP-500 (HF-2545B)	
Model of heating filament	Platinum-iridium alloy(platinum90%, iridium10%)W× L of square box; HF=Heating Filament, B=Box
HF-3025B	2.5×3.0mm
HF-3030B	3.0×3.0mm
HF-2545B	4.5×2.5mm
Model of borosilicate glass with filament	Borosilicate glass with filament(O.D.×I.D.×L)B=Borosilicate, F=Filament
B-15086-10F	1.5×0.86×100mm
B-10050-10F	1.0×0.5×100mm
B-10078-10F	1.0×0.78×100mm
B-12069-10F	1.2×0.69×100mm
B-12094-10F	1.2×0.94×100mm
B-150110-10F	1.5×1.1×100mm

## Motorized Micromanipulator ▶

### MM-500 Motorized Micromanipulator

Electric micromanipulators are mostly used to manipulate recording electrodes and stimulate the movement of electrodes in electrophysiological experiments.

The MM-500 was designed to meet a wide variety needs for the scientific community, and is suitable for patch clamp experiments, microinjection, extracellular recording, intra-cellular recording and precision robotic positioning applications.



#### Features:

- Small and light size, humanized bilingual operation interface, flexible program debugging.
- The TFT screen shows the position and moving speed of the activated manipulator as well as X, Y and Z.
- High-resolution stepper motor meets four-axis drive, the maximum distance of X, Y, Z and diagonal movement is 25mm, with good stability and small drift.
- A rotary photoelectric encoder can control two manipulators and switch freely. Origin/working position function can meet the requirement of rapid return of electrode to original position/working position.
- Compatible with mainstream micromanipulation platform, can be used with any microscope, can hold a variety of probes and microsyringes.

#### Technical parameters:

Parameter item	Specification
Travel	25 mm on all four axes
Maximum Speed	2.9mm/s
Resolution	0.132 $\mu$ m/0.033 $\mu$ m
Long Term Stability	10nm/h at 24°C.
Repeated positioning accuracy	Single axis $\leq$ 1 $\mu$ m, three axis $\leq$ 2 $\mu$ m

#### Order Information:

Model of micropipette puller	Product Description
MM-500-2	Motorized micromanipulators(Double-handed setup)
MM-500-L	Motorized micromanipulators(Left-handed setup)
MM-500-R	Motorized micromanipulators(Right-handed setup)
MM-500L	Left-handed mechanical manipulator
MM-500R	Right-handed mechanical manipulator
MT-500	Microscope moving platform: Contain 3 supporting columns, 1XY mobile platform, 1microscope mounting bracket, 1XY mobile platform mounting bracket

# In Vivo Imaging Solution

## Laser Speckle Imaging System

Based on the Laser Speckle Contrast Imaging(LSCI) technology, RFLSI III provides real-time and full-field blood perfusion calculation. In non-contact way, reliable quantified data and high definition images could be obtained for various of pre-clinical research. It can be used to record the microcirculation of any exposed organ.



12X Zoom with Autofocus, 120 frames/sec

Non-contact, No contrast agent

Real time, Full field imaging

Multi-output: Data, Video, Image; on-line state and off-line state

### Product Features

### Performance Characteristics:

- The 2048×2048 resolution of the images that directly generated is the highest resolution among all the similar products.
- 12X Zoom with autofocus and 120 frames per second ensure the details of the blood perfusion calculated are as much as the eye can see.
- Stable laser output combine with optimized algorithm guarantee the accuracy of the quantification of blood perfusion.
- Changes of the vessel diameter contained in the recorded data along with videos and images could be analysed in on-line state or off-line state to maximum efficiency.
- Solutions of the scientific research with timely after-sale service offered by RWD will make a great assistant in your daily research.

### References:

- Activation of the XBP1s/O-GlcNAcylation pathway improves functional outcome after cardiac arrest and resuscitation in young and aged mice
- Snake C-Type Lectins Potentially Contribute to the Prey Immobilization in Protobothrops mucrosquamatus and Trimeresurus stejnegeri Venoms
- Protein O-GlcNAcylation alleviates small intestinal injury induced by ischemia-reperfusion and oxygen-glucose deprivation
- Mechanically Induced Vasospasm Evaluation of Spasmolytic Efficacy of 10 Pharmaceutical Agents Using Laser Speckle Contrast Imaging
- Aging exacerbates impairments of cerebral blood flow autoregulation and cognition in diabetic rats
- Microvascular Injury in Mild Traumatic Brain Injury Accelerates Alzheimer-like Pathogenesis in Mice
- SP6616 as a Kv2.1 inhibitor efficiently ameliorates peripheral neuropathy in diabetic mice
- Arterial Supercharging Is More Beneficial to Flap Survival Due to Quadruple Dilation of Venules

► Related research topics

- Cerebral Cortex Blood Perfusion Monitoring
- Hindlimb Ischaemia Research
- MCA-Occlusion Assessment
- Skin Burn/Skin Flap Transplantation Research
- Cortical Spreading Depression Observation
- Organ Microcirculation Observation

Technical Parameters:

Type	RFLSI III
Scope of perfusion	0 – 5000PU
Imaging acquisition rate	up to 120 frames/sec
Working distance	10-35cm
Monitoring Area	1.57 × 1.57mm – 90 × 90mm
Image resolution up to	2048 × 2048
Zoom range	12X Optical Zoom with Auto-focus
Maxmium spatial resolution	up to 3µm/pixel
Wavelength	785nm
Indicated Laser Wavelength	660nm

Software interface:

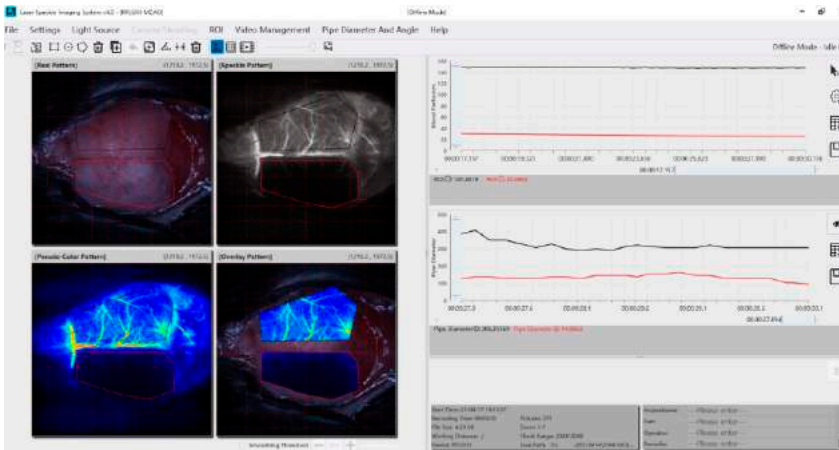

Middle Cerebral Artery Occlusion Mouse Model with Realtime Data of Blood Perfusion and Pipe Diameter.

► Case show

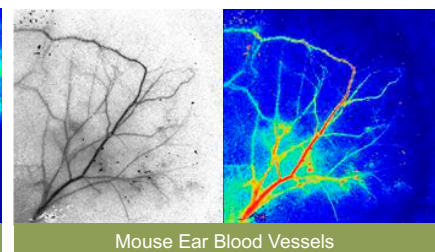
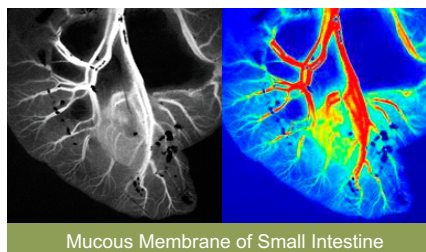
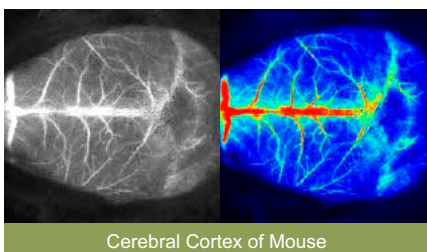
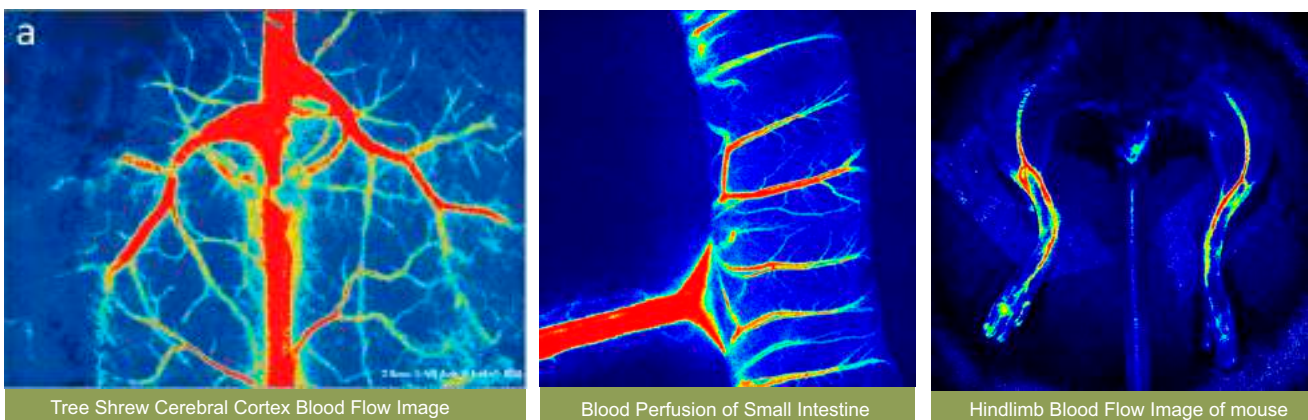

In Vivo Imaging Solution

# Animal Administration and Blood Sampling Solution

## Drug Delivery Cannula

Cannula implantation is the international general method for acute and chronic intracranial drug administration in animal experiments. RWD offers customized services for users, the users can customize according to specific experimental requirements.



### Single Cannula

#### Components:

#### Guide cannula

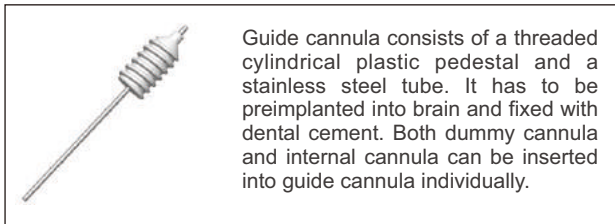

Guide cannula consists of a threaded cylindrical plastic pedestal and a stainless steel tube. It has to be preimplanted into brain and fixed with dental cement. Both dummy cannula and internal cannula can be inserted into guide cannula individually.

#### Dummy cannula

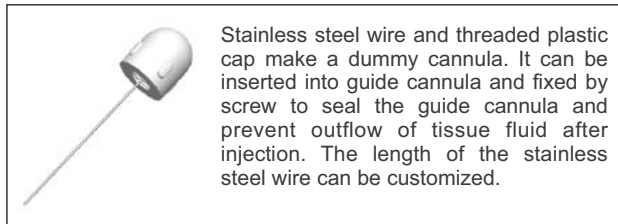

Stainless steel wire and threaded plastic cap make a dummy cannula. It can be inserted into guide cannula and fixed by screw to seal the guide cannula and prevent outflow of tissue fluid after injection. The length of the stainless steel wire can be customized.

#### Metal Cannula

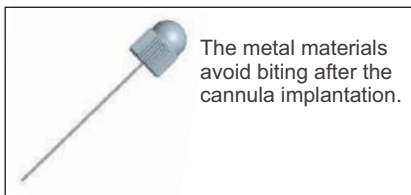

The metal materials avoid biting after the cannula implantation.

#### Internal cannula

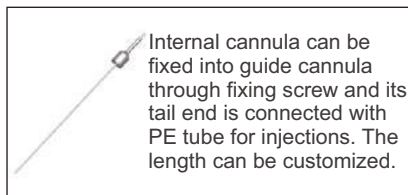

Internal cannula can be fixed into guide cannula through fixing screw and its tail end is connected with PE tube for injections. The length can be customized.

#### Fixing screw

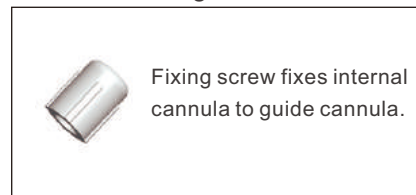

Fixing screw fixes internal cannula to guide cannula.

#### Cording Diagram:

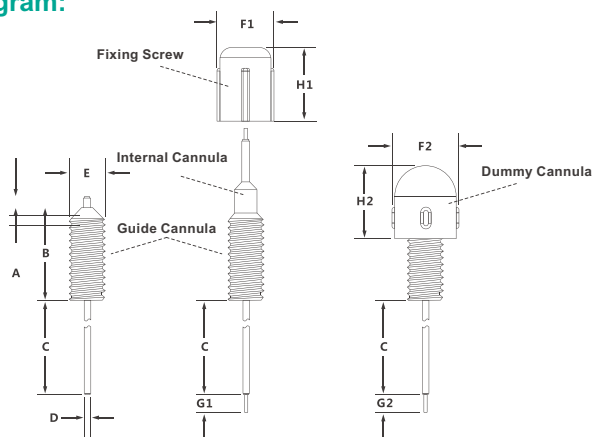

Single-Cannula connection

#### Diagrams:

- A - The length of the stainless steel tubing below the plastic pedestal.
- B - The height of the cylindrical plastic base.
- C - The length of the stainless steel tubing below the plastic pedestal, can be customized.
- D - External diameter of stainless steel guide cannulas.
- E - External diameter of cylindrical plastic base.
- F1 - External diameter of Fixing screw.
- F2 - External diameter of Dummy Cannulas.
- H1 - Height of Fixing screw.
- H2 - Height of Dummy Cannulas.
- G1 - The internal cannulas projection length beyond the guide cannulas tip, can be customized.
- G2 - The dummy cannulas projection length beyond the guide cannulas tip, can be customized.

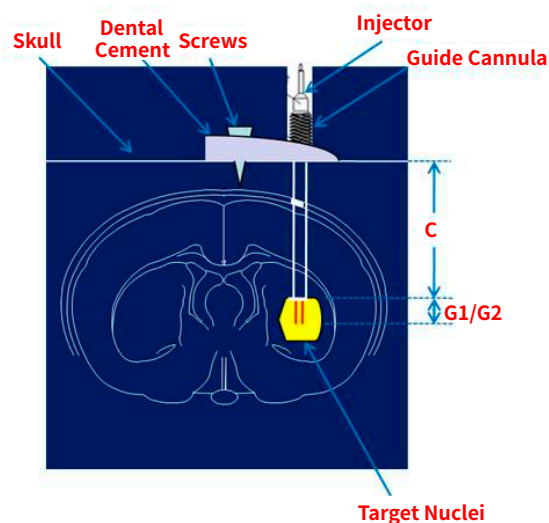
**Ordering Instructions:****Diagram for Customization**

- D-outer diameter of the Guide Cannula (Unit:g) , five sizes 22, 23, 24, 26 and 27g are available.
- C-length (Unit: mm) of the metal tube below the plastic pedestal (B).
- G1-length (Unit: mm) of the protrudent Injector through the Guide Cannula, 0.5 or 1.0mm is recommended.
- G2-length (Unit: mm) of the protrudent Dummy Guide, 0.5 or 1.0mm is recommended.

**Order information (Unit: mm):**

Matching	Guide Cannula (OD x ID)	Internal Cannula (OD x ID)	Dummy Cannula (plastic OD)	Dummy Cannula (metal OD)	Fixing Screw	PE Tube	Range of customized length		
							C	G1	G2
Cannula	62001(23g) 0.64x0.45	62201 0.41x0.25	62101 0.4	62106 0.4	62502	62329	0.5~15	0.5~15	0.5~15
	62002(24g) 0.56x0.38	62202 0.36x0.2	62102 0.3	62107 0.3					
	62003(26g) 0.48x0.34	62203 0.3x0.14	62102 0.3	62107 0.3					
	62004(27g) 0.41x0.25	62204 0.21x0.11	62104 0.2	62108 0.2					
	62005(22g) 0.71x0.45	62201 0.41x0.25	62101 0.4	62106 0.4					

**Notes:** The height and external diameter of the cylindrical plastic base are 8mm and 3.5mm respectively. Plastic or metal dummy cannula is optional.

**Double Cannula****Introduction:**

RWD has launched I, II, III and IV series double cannula systems for acute and chronic intracranial drug administration in animal experiments.

Series I: Recommended for rat or mouse use, 0.48mm (outer diameter) x 0.34mm (internal diameter).

Series II: Recommended for rat use, 0.64mm (outer diameter) x 0.45mm (internal diameter).

Series III: Specifically for mouse use, 0.48mm (outer diameter) x 0.34mm (internal diameter). The height of cylindrical plastic pedestal of Guide cannula is different from Series I.

Series IV: 0.41mm (outer diameter) x 0.25mm (internal diameter).

**Application:**

Double cannula system is used for bilateral implantation, suitable for injecting one or two drugs into two different brain regions.

**Cording Diagram:**

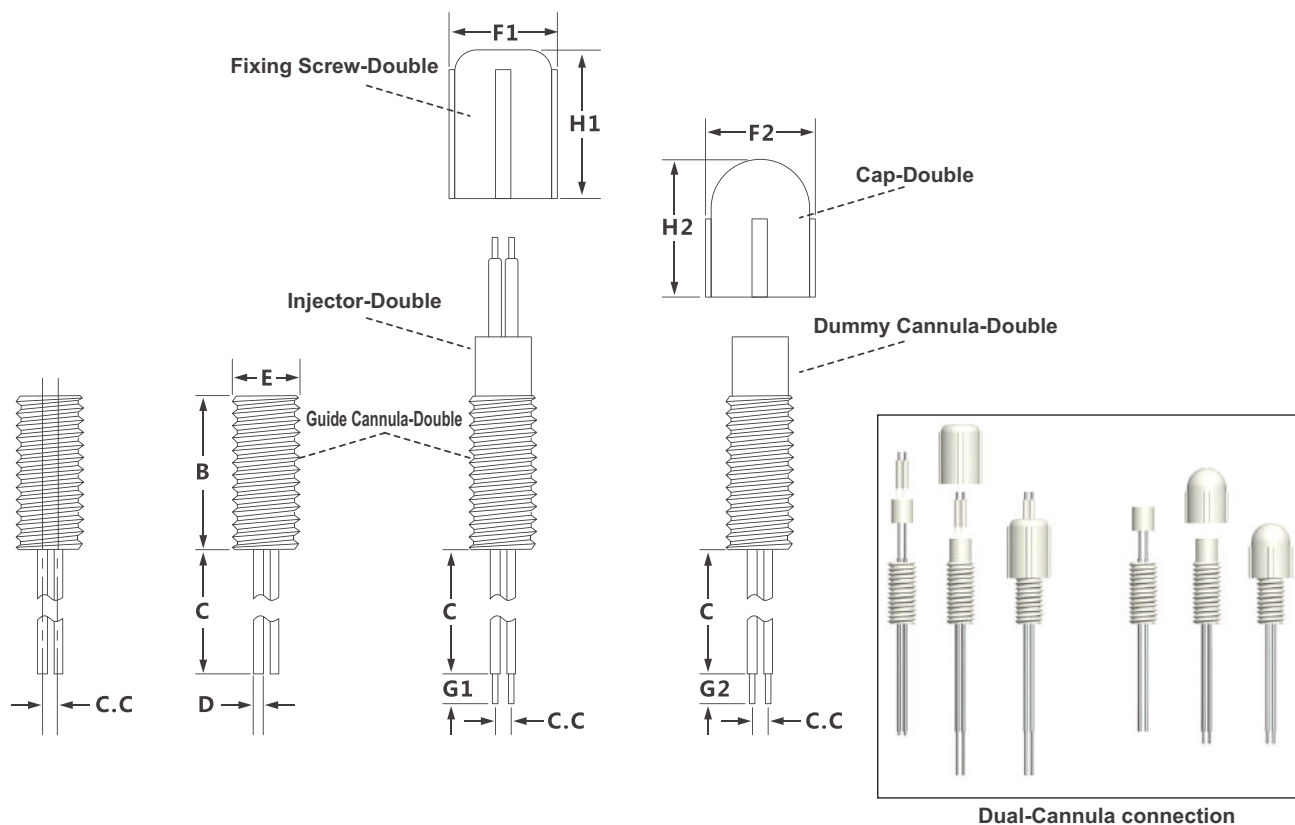

**Comments:**

- B - Height of cylindrical plastic pedestal which is 7.8mm for Series I, II & IV and 5.5mm for Series III
  - ★ C - Length of stainless steel tube below the cylindrical plastic pedestal. The default value is 13.7mm for Series I & III, 20.0mm for Series II and 10.0mm for Series IV. The length can be customized with default value as maximum
  - ★ C.C - Center distance between double guide cannulas, double dummy cannulas and double injectors. These 3 values should be the same in one system. It can be customized (range: 0.5mm-3.0mm)
- D - Outer diameter of stainless steel tube and it has 3 sizes: 0.48mm for Series I & III, 0.64mm for Series II and 0.41mm for Series IV
- E - Outer diameter of the cylindrical plastic pedestal and it comes with 3.5mm or 5.0mm. It is related to the outer diameter and centre distance between double guide cannulas
- F1 - Outer diameter of fixing screw and it comes with 5.0mm (when E=3.5mm) or 7.0mm (when E=5.00mm)
- F2 - Outer diameter of guide cannula cap and it comes with 5.5mm (when E=3.5mm) or 7.0mm (when E=5.0mm)
- H1 - Height of the fixing screw and it comes with 7.5mm (when E=3.5mm) and 8.0mm (when E=5.0mm)
- H2 - Height of guide cannula cap and it comes with 7.00mm (when E=3.5mm) and 7.5mm (when E=5.0mm)
  - ★ G1 - Length of protruding part after internal cannula is inserted into guide cannula. This length can be customized
  - ★ G2 - Length of protruding part after dummy cannula is inserted into guide cannula. This length can be customized

**Ordering Instructions:**

Determine the target brain region for drug administration and then determine target values of C, C.C, G1 and G2. These values can not exceed the default ones. Please refer to :

- ★ part of comments of cording diagram for more detail.
- ★ C: Maximal customized length is 13.7mm for Series I & III, 20.0mm for Series II and 10.0mm for Series IV.
- ★ C.C: Customized range is 0.5mm-3.0mm.
- ★ G1: Maximal customized length is 6.0mm for Series I, 4.0mm for Series II, 8.0mm for Series III and 4.0mm for Series IV.
- ★ G2: Maximal customized length is 2.0mm for Series I, 5.0mm for Series II, 4.0mm for Series III and 5.0mm for Series IV.



## Order Information: (Unit: mm)

## Series I: Recommended for rat or mice

Matching	C.C	Guide Cannula	Internal Cannula	Dummy Cannula	Cap	Fixing Screw	PE Tube	Range of customized length		
								C	G1	G2
Cannula (26G) O.D.0.48mmxI.D.0.34 mm Dummy Cannula: O.D.0.30mm Internal Cannula: O.D.0.30mm x I.D.0.14mm Plastic Pedestal of Guide Cannula: Height B = 7.8mm Diameter E = 3.5mm	0.5	62021	62250	62121	62523	62521	62320	0.5~13.7	0,0.5~6	0,0.5~2
	0.6	62022	62250	62122						
	0.8	62023	62223	62123						
	1.0	62024	62224	62124						
	1.2	62025	62225	62125						
	1.3	62026	62226	62126						
	1.4	62027	62227	62127						
	1.5	62028	62228	62128						
	1.6	62029	62229	62129						
	1.8	62030	62230	62130						
Plastic Pedestal of Guide Cannula: Diameter E = 5 mm	2.0	62031	62231	62131	62524	62522	62329	0.5~20	0,0.5~4	0,0.5~5
	2.2	62032	62232	62132						
	2.4	62033	62233	62133						
	2.6	62034	62234	62134						
	2.7	62035	62235	62135						
3.0	62036	62236	62136							

## Series II: Recommended for rat

Matching	C.C	Guide Cannula	Internal Cannula	Dummy Cannula	Cap	Fixing Screw	PE Tube	Range of customized length		
								C	G1	G2
Cannula(23G) O.D.0.64mmx I.D.0.45 mm Dummy Cannula: O.D.0.40mm Internal Cannula: O.D.0.41mm x I.D.0.25mm Plastic Pedestal of Guide Cannula: Height B = 7.8mm Diameter E = 3.5 mm	0.8	62037	62237	62137	62523	62521	62323	0.5~20	0,0.5~4	0,0.5~5
	1.0	62038	62238	62138						
	1.2	62039	62239	62139						
	1.3	62040	62240	62140						
	1.4	62041	62241	62141						
	1.5	62042	62242	62142						
	1.8	62043	62243	62143						
Plastic Pedestal of Guide Cannula : Diameter E = 5 mm	2.0	62044	62244	62144	62524	62522	62329	0.5~20	0,0.5~4	0,0.5~5
	2.2	62045	62245	62145						
	2.4	62046	62246	62146						
	2.5	62047	62247	62147						
	2.8	62048	62248	62148						
3.0	62049	62249	62149							

## Series III: Recommended for mice

Matching	C.C	Guide Cannula	Internal Cannula	Dummy Cannula	Cap	Fixing Screw	PE Tube	Range of customized length		
								C	G1	G2
Cannula (26G) O.D.0.48mmxI.D.0.34 mm Dummy Cannula: O.D.0.30mm Internal Cannula : O.D.0.30mm x I.D.0.14mm Plastic Pedestal of Guide Cannula: Height B = 5.5mm Diameter E = 3.5mm	0.5	62050	62250	62121	62523	62521	62320	0.5~13.7	0,0.5~8	0,0.5~4
	0.8	62052	62223	62123						
	1.0	62053	62224	62124						
	1.2	62054	62225	62125						
	1.3	62055	62226	62126						
	1.4	62056	62227	62127						
	1.5	62057	62228	62128						
	1.6	62058	62229	62129						
	1.8	62059	62230	62130						
2.0	62060	62231	62131							

**Series IV: Recommended for mice**

Matching	C.C	Guide Cannula	Internal Cannula	Dummy Cannula	Cap	Fixing Screw	PE Tube	Range of customized length		
								C	G1	G2
Cannula (27G) O.D.0.41mm x I.D.0.25 mm Dummy Cannula: O.D.0.20mm Internal Cannula: O.D.0.21mm x I.D.0.11mm Plastic Pedestal of Guide Cannula: Height B = 7.8mm Diameter E = 3.5mm	0.5	62061	62251	62161	62523	62521	62320	0.5~10	0,0.5~4	0,0.5~5
	0.6	62062	62251	62162						
	0.8	62063	62263	62163						
	1.0	62064	62264	62164						
	1.2	62065	62265	62165						
	1.3	62066	62266	62166						
	1.4	62067	62267	62167						
	1.5	62068	62268	62168						
	1.6	62069	62269	62169						
	1.8	62070	62270	62170						
2.0	62071	62271	62171							

Notes : (1)For cap, plastic or metal is optional. Metal cap 62525 (corresponding plastic cap 62523), Metal cap 62526 (corresponding plastic cap 62524).

(2)The difference between Series I and Series III is the height of the pedestal, the former is 7.8mm and the later is 5.5mm, and Series III is specially designed for mice

## PE & Silicone Tubings

PE(Polyethylene) / HDPE(High Density Polyethylene) tube, with good fluidity, high thermal stability and good flexibility, is widely used in the field of life science. Currently, RWD has 9 types of PE tube and 1 type of silicone tube, including the international standard tubes PE10, PE20 and PE50, which can be used in microdialysis, animal artery intubation, venous cannula, bile duct intubation, subcutaneous implantation of buried pipe, lateral ventricle buried pipe, portal vein intubation and so on. These tubes can be used together with syringe, guide cannula, microdialys connector and luer stubs.

### Order Information:

No.	Model	Product Description
1	62320	PE Tubing-0.85*0.42mm, pkg of 10m
2	62321	PE Tubing (HDPE)-0.85*0.42mm, pkg of 10m
3	62322	PE Tubing-0.50*0.25mm, pkg of 10m
4	62323	PE Tubing-1.00*0.50mm, pkg of 10m
5	62324	PE10 Tubing-0.61*0.28mm, pkg of 10m
6	62325	PE20 Tubing-1.09*0.38mm, pkg of 10m
7	62326	PE25 Tubing-0.91*0.46mm, pkg of 10m
8	62327	PE50 Tubing-0.97*0.58mm, pkg of 10m
9	62328	PE60 Tubing-1.20*0.80mm, pkg of 10m
10	62329	PE Tubing-1.50*0.50mm, pkg of 10m



Note: Except 62322, other PE tube can withstand high-pressure steam sterilization(121°C, 30min).

## Screws



Model	Product Description
62513	Screw-M1.0xL2.0mm
62514	Screw-M1.2xL2.0mm
62515	Screw-M1.4xL2.5mm

# Osmotic Pumps

The osmotic pump has become the best tool for continuous dose of unrestrained laboratory animals. It can be implanted subcutaneously or intraperitoneally in animals. Minimizes side effects and experimental variables, and reduces the risk of stress due to frequent animal handling. And it is used for continuous delivery of a wide range of drugs, including antibodies, growth factors, cytokines, chemotherapeutics, addictive drugs, hormones, steroids and more.



## Features:

- Ensure continuous and uninterrupted administration, maintaining the preset speed for the administration of the animal.
- Storage capsules have good drug compatibility, and protection for short half-life drugs.
- Capsules have good biocompatibility and do not affect the physiology of animals.
- Easy to use, It allows one-time operation in an experiment instead of frequent operation.
- Avoid the stress caused by repeated administration, reducing the impact of non-experimental factors on the experimental results.
- Small size, can be applied to experiments on mice, neonatal rats and other small animal.
- Ensure that the drug is delivered to the target site accurately.

The osmotic pump can be directly implanted in the abdominal cavity or the back of the neck for drug administration, or it can be applied to specific tissue and organ, such as blood vessels, brain, spinal cord, lungs, liver, etc., by connecting the catheter or other accessories.

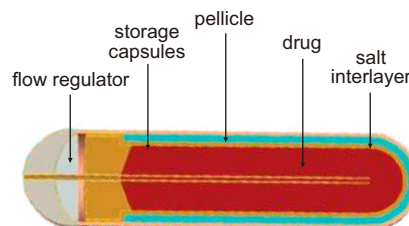

- Flow regulator: The sole outlet for drug solution, which is used to connect the catheter to target administration area.
- Storage capsules: Fill with solution. It has good corrosion resistance to acid and alkali.
- Shell: Firmness, designed to protect the internal structure of osmotic pump, with fluid passability characteristics.
- Salt interlayer: absorption of tissue fluid by osmosis. After the salt interlayer absorbs the tissue fluid, it can only be extruded inwards to slowly pump the solution out of the capsule.
- Pellicle: prevents the salt layer from diffusing into the tissue, and ensures that the tissue fluid can enter the salt layer to squeeze the storage capsule and pump out the drug solution

## Technical Parameters:

Capsule (10pcs/box)	Drug capacity	100µL				200µL				2mL		
	Type	1003D	1001W	1002W	1004W	2003D	2001W	2002W	2004W	2ml1W	2ml2W	2ml4W
	Duration	3d	1w	2w	4w	3d	1w	2w	4w	1w	2w	4w
	Pumping Rate(µL/hr)	1.0	0.5	0.25	0.125	2.0	1.0	0.5	0.25	10.0	5.0	2.5
Flow regulator (10pcs/box)	Cap	Without				PE material						
	Draft tube	304 stainless steel material										
Infusion tube (1pcs/box)	Syringe	Flat head for the injection of liquid										

## Osmotic pump kit ordering information:

	Model	Description
Brain Infusion Kit	Bic-3	For 1-3mm deep brain area administration (10 Bags/ Package)
	Bic-5	For 1-3mm deep brain area administration (10 Bags/ Package)
Catheter Delivery Kit	Mic	For long-distance muscle administration (10 Bags/ Package)



Different accessory kits

Animal Administration and Blood Sampling Solution

# Blood Sampling and Administration System

The catheter is surgically inserted into the target location (jugular vein, carotid artery, bile duct, portal vein, etc.), and the Implant Button is then fixed subcutaneously, allowing simultaneous drug administration and blood sampling. It is suitable for manual continuous and repeated blood sampling and drug administration, long-term automatic drug administration and blood sampling by machine.

## Features:

- Suitable for up to 10 sampling sites such as jugular vein, carotid artery, femoral vein and bile duct.
- The design is compact and firm, not easy to be damaged by animals, and the biocompatibility has been verified by experiments.
- It can be matched with syringes, catheters and other sampling methods.
- Effectively reduce the stress reaction caused by repeated injection.



## Components:

### Implant Button



The Implant Button consists of transparent shell, magnet, felt and capillary tube. Catheter is connected to capillary tube and inserted into a blood vessel. The Button is implanted subcutaneously and fixed by suturing the epidermis.

### Pharmport



The Pharmport consists of shell (red and white) and capillary tube, sizes: 25g and 22g. The Pharmport is connected with the Implant Button as a simple infusion and blood sampling device.

### Catheter connector



The Catheter connector is composed of shell and capillary tube, size: 25G, 22G. For connecting Pharmport and PE tubes in vitro.

### Syringe connector



Syringe connector is composed of transparent shell and capillary tube, with a size of 25G. The front end of the injection needle can be directly inserted into the Pharmport for infusion and blood sampling, the rear end can be connected with the standard syringe.

### Implant Button Cap



The Implant Button cap is made of high quality duralumin alloy and magnet. When the Implant Button is not in use, The cap can be used to ensure that the injection end is not contaminated. The magnet allows the operator to quickly attach the cap to Implant Button.

### Handling



The Handling is made of high quality duralumin alloy and magnet. Fix the animal with one end of the Handling to pull out the Implant Button Cap, and then use the other end (including magnet) to continue to fix the animal for infusion or blood sampling operation.

### Catheter



The size of the catheter matches the capillary of the Implant Button, and the catheter can be inserted into the blood vessels of experimental animals. The node ensures that the catheter is not easy to fall off after implantation.

**Order Information:**

Product Description	Model
Implant Button (single channel 25G for mice-white)	BMSW25
Implant Button (mouse dual channel 25G/25G)	BMD25/25
Implant Button (single channel 22G for rat-white)	BRSW22
Implant Button (single channel 22G for rat-Rad)	BRSR22
Implant Button (Rat dual channel 22G/22G)	BRD22/22
Catheter connector (22G)	C22
Catheter connector (25G)	C25
Syringe connector	SC-1
Pharmport (22G Red)	P22-R
Pharmport (22G White)	P22-W
Pharmport (25G Red)	P25-R
Pharmport (25G White)	P25-W

Product Description	Model
Implant Button Cap (mouse single channel-silver)	CMSC-S
Implant Button Cap (mouse single channel-gold)	CMSC-G
Implant Button Cap (mouse dual channel-silver)	CMDC-S
Implant Button Cap (mouse dual channel-gold)	CMDC-G
Implant Button Cap (rat-silver)	CRSC-S
Implant Button Cap (rat-gold)	CRSC-G
Handling	BH
Carotid Artery Catheters for Rats	PURCA
Jugular Vein Catheters for Rats	PURJV
Bile Duct Catheters for Rats	PURBD
Portal Vein Catheters for Rats	PURPV
Femoral Artery Catheters for Rats	PURFA
Femoral Vein Catheters for Rats	PURFV
Jugular Vein Catheters for Guinea pigs	PUCJV
Carotid Artery Catheters for Guinea pigs	PUCCA
Carotid Artery Catheters for Mice	PUMCA
Jugular Vein Catheters for Mice	PUMJV

Product Description	Model
Swivels ( Single Channel 22G)	SS1-22
Swivels ( Single Channel 25G)	SS1-25
Swivels Mount for Mice	MLA-M
Swivels Mount for Rats	MLA-R
Tether (mouse single channel)	TM-1
Tether (mouse dual channel)	TM-2
Tether (drug administration for Rat)	TR-1dr
Tether (blood sampling for Rat)	TR-1bl
Tether (rat dual channel)	TR-2
Bile Loop	DZXHQ
PE Tubing 22	BC-22
PE Tubing 25	BC-25

# Syringe Pumps

## 462 Syringe Pump

RWD series syringe micro-injection pumps are widely used in scientific research. The upgrade from the first generation to the current second-generation products includes single-channel and dual-channel options.



### Features:

- Control the stepper motor for stable and high-precision operation at low speed.
- The communication with the touch screen of the host computer can control the output torque and rotation speed of the stepper motor according to the input, and then control the injection thrust and injection speed.
- Reserved communication interface (BNC, USB-B, and PC communication, RS485 multi-injection pump communication).
- Can input and output, 15-pin D-sub Connector.
- With encoder, feedback speed, alarming when speed is abnormal, equipment operation suspend.
- Safety certification: EMC, ESD, and CE.
- Running indicator: convenient for users to intuitively discover the current status of the pump.

### Order Information:

Model	Name	Note
R462	RWD 462 Syringe Pump	Dual-channel

### Technical Parameters:

Operating mode	Injection/withdrawal
Injection accuracy	$\pm < 0.35\%$
Repeatability	$\pm < 0.05\%$
Syringe range	0.5 $\mu$ L-60 mL
Minimum flow rate	0.0001 $\mu$ L / min (0.5 $\mu$ L syringe)
Maximum flow rate	102 mL/min (60 mL syringe)
Linear thrust	50lbs (23 kg)
Operating temperature	4 °C to 40 °C
Storage temperature	-10 °C ~ 70 °C
Humidity	20% to 80%, non-condensing
Communication interface	USB-B, BNC, RS485 and TTL ports
Advance stroke per step	0.046 $\mu$ m / step
Display	5.0-inch LCD touch screen

## R480 Nanoliter Injection Pump

The newly launched R480 Nanoliter Injection Pump is highly precise & airtight, stable & easy to operate, which can be used to accurate microinjection or suction for oocytes, larva, protozoa, animal brain, eyeball, etc.



### Features:

- Stable operation and high injection precision
- High airtightness, ensures no leakage during injection or withdrawal
- The brightness of the screen can be adjusted to meet different experimental situations
- Added the function to set needle retention time. A timer is no longer required if the needle is retained after the injection

### Technical Parameters:

Operating mode	Injection/withdrawal
Injection Volume	0.6 nL-5000 nL
Minimum flow rate	1 nL/s
Maximum flow rate	200 nL/s
Emptying rate	10nL-200nL/s
Withdrawing rate	10 nL-200 nL/s
Glass Capillary size	OD1.14mm, ID0.53mm
Minimum injection volume resolution	0.1nL
Circle	1-8000
Display	5.0-inch LCD touch screen

### Order Information:

Accessory Name	Description	Quantity	
R480 Nanoliter Injection Pump	Host(including Injector Head )	1	Standard configurations
Power wire	Plug-in power wire for device power input	1	
3.5-inch (8.89cm) glass capillary	Attached to the Injector head for injection;OD1.14mm,ID0.53mm	100	
7-inch (17.78cm) glass capillary	Attached to the Injector head for injection;OD1.14mm,ID0.53mm	100	
Fixed fittings	For conjunction with brain stereotaxer and micromanipulator	1	
Filling needle	For Filling Mineral Oil: 30 Gauge, 2" length	1	
Sealing material	For replacing the sealing material inside the Injector Head	1	
Foot switch	For foot controlled injection	1	Optional Accessories
Mineral Oil	100mL/ bottle	1	
Special fixing accessories for micromanipulator	With special accessories for RWD Motorized Micromanipulator	1	

# Pathological Section Solution

## Minux® Rotary Microtomes

Rotary microtome is a device for paraffin section, widely used in medical and biological research. It is used for pathological diagnosis in clinical, and used for research at the tissue and cell level.



### ► Features:

#### Visual pointer

- » Designed with the visual pointer on precise positioning system, easy to adjust the sample to the target angle, reducing trimming and sample waste.
- » Adjust multiple devices to the same angle easily and quickly.

#### The side knobs

- » Integrated with the machine, ergonomic design, make operation more comfortable and coordinated.
- » The sample feeding speed can be adjusted freely between 0-1800µm/s, more choice and more efficient.
- » Durable military-grade devices, service life is more than 20 million times.

#### Automatic section

- » It is stable and maintains slice consistency.
- » No extra skills required, easy to complete the operation.
- » Some specimens such as embryos and brains need to be cut for hundreds of pieces. It is hard for you, but easy for automatic section.

#### Easily removable waste tray

- » With magnetic function, easy to disassemble and install.
- » Special coating materials tray, easy to clean up, shorten the cleaning time to a few seconds.



## ► Technical Parameters

Parameters	Model	S700 Semi-Automated	S700A Fully-Automated
Section thickness setting range: 0.5 - 100 $\mu\text{m}$		✓	✓
Trimming section thickness setting range: 1 - 800 $\mu\text{m}$		✓	✓
Electric coarse feed speed: 0-1800 $\mu\text{m/s}$		✓	✓
Specimen retraction: 0-250 $\mu\text{m}$		✓	✓
Specimen feed: 28mm, vertical stroke: 70mm		✓	✓
Specimen orientation: X/Y axis 8°, Z axis 360°		✓	✓
Maximum specimen size: 55*50*30mm		✓	✓
Automated mode and manual mode switch			✓
Emergency stop button			✓
Cut window function			✓
Slice speed selection			✓
Four slice modes: Int.,Single,Cont., Multi.			✓
Pedals(optional)			✓

## ► Order Information

Cat No.	Product Description
S700A	Fully-Auto rotary microtome, include a box of blades(50 pcs)
S700	Semi-Auto rotary microtome, include a box of blades(50 pcs)
S700-F3	Universal clamp
S700-F4	Standard clamp
S700-F7	Blade holder assembly
S700-F9	Blade holder upper bracket
S700-F10	Easy-clean waste tray
S700-F6	Antistatic waste tray

## ► Disposable Microtome Blades-low profile



### ► Features:

- Sharp and durable, cost-effective
- For rotary microtomes and cryostats use
- Packed in a push-out distribution box for easy access

## Order Information

Cat No.	Product Description
PB-1 Pro	Disposable Microtome Blades, 80mm*8mm*0.25mm, 50 pcs, for paraffin and frozen section

## Minux® Cryostats

Cryostat is a device for rapidly cooling tissue to a certain hardness under low temperature conditions and then slicing. It is a quick and easy method.

Hospitals mainly use it for rapid pathological diagnosis during surgery. Researchers use it for preparation of biological tissue samples for in situ hybridization, immunohistochemistry, etc.



### ► Features

#### Stable

- **Stable temperature:** advanced temperature control system, small temperature fluctuations. Even if the window is opened for more than 1 hour, the temperature is still stable.
- **Stable slice quality:** high-precision cross rail and screw, five-phase high-resolution sampling motor and horizontal sampling slider made of aviation aluminum, form a precise sampling system to ensure stable slice quality.

#### Safe

- **UVC disinfection:** the latest low-temperature UVC disinfection technology. The irradiation intensity can effectively kill bacteria and viruses, disinfect the inner surface and the air of the cabinet, and reduce the risk of contamination by infectious materials.
- **Waste liquid management system:** a waste liquid volume display on the touch screen. There are reminders of full bottle and not in place to prevent waste liquid from flowing out and contaminating the ground.

#### Efficient

- **Efficient operation:** the color touch screen, with a joystick that integrates coarse sample feeding, trimming and section switching, and slice parameter adjustment, constitutes an efficient operating system.

- **Quick positioning:** precise positioning system with  $\pm 8^\circ$  visual pointer, easy to adjust the specimen clamp to the target angle, reducing trimming and sample waste.
- **Automatic sleep and wake-up:** saving energy, simplify manual operation and reduce waiting time.
- **Sample installation and marking:** Buckle design, convenient installation and firm fixation. The unique label design of specimen discs makes it easy to record and identify each sample to prevent confusion.
- **Efficient and thorough defrosting:** automatic defrosting for cryochamber, specimen head, quick-freeze shelf, more thorough. For manual defrosting, there are different parts to choose to improve efficiency.

## ► Technical Parameters

Parameters	Model	FS800 Semi-Automated	FS800A Automated
Section thickness setting range: 0.5 - 100 $\mu\text{m}$		✓	✓
Trimming section thickness setting range: 1 - 800 $\mu\text{m}$		✓	✓
Electric coarse feed speed: 0-1800 $\mu\text{m/s}$ adjustable		✓	✓
Specimen retraction: 0-250 $\mu\text{m}$		✓	✓
Specimen feed: 28mm		✓	✓
Vertical stroke: 70mm		✓	✓
Specimen orientation with visual pointer: X/Y axis $8^\circ$ , Z axis $360^\circ$		✓	✓
Number of refrigerated sites: 15		✓	✓
Number of fast cooling sites: 2		✓	✓
Cryochamber temperature range: $0^\circ\text{C}\sim-35^\circ\text{C}$		✓	✓
Automatic and manual defrosting		✓	✓
Automatic and manual UVC disinfection		✓	✓
Automated mode and manual mode switch			✓
Emergency stop button			✓
Cut window function			✓
Slice speed selection			✓
Four slice modes: Int.,Single,Cont., Multi.			✓
Pedals(optional)			✓

## ► Order Information

Cat No.	Type	Product Description
FS800	UV	Semi-Auto,with UVC disinfection function
	Specimen	Semi-Auto,with UVC disinfection,specimen cooling system
	Vacuum	Semi-Auto,with UVC disinfection,Vacuum,specimen cooling system
FS800A	Auto	Fully-Auto,with UVC disinfection,specimen cooling system,auto section function
	Max	Fully-Auto,with UVC disinfection,vacuum,specimen cooling system,auto section function

# Cellular and Molecular Biology Research Solution

## Single Cell Suspension Dissociator

RWD Single cell suspension dissociator uses tissue processing tubes, tissue dissociation kits, and built-in optimization programs for preparing high-activity single-cell suspension and tissue homogenate. The preparation of single-cell suspension with high cell viability can be completed within 15-30 minutes, which makes the experiments more reproducible. 4 independent operating channels and heating jackets can automate the processes and improve the efficiency of tissue processing. It is widely used in single-cell sequencing, primary cell culture, fluorescence-activated cell sorting, cell therapy, and other research fields.

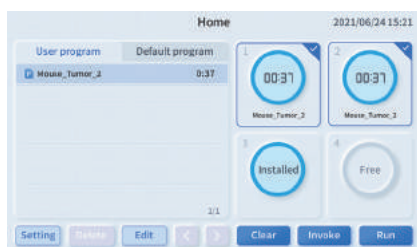

Tube position detecting

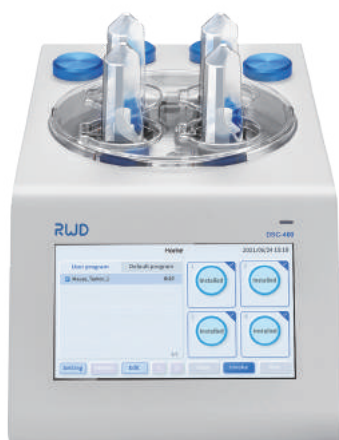

Single Cell Suspension Dissociator



Visualized and editable programs

### Features

#### Intelligent

- Pre-defined standard processes and customized processes supported.
- Processes can be imported and synchronized via USB ports.

#### Gentle

- Stable motor speed ranges from 20 to 4000 rpm.
- Customized tissue dissociation kits and tissue processing tubes can ensure cell viability and reduce experimental losses.

#### Safe

- Multiple alarms guarantee the safety of both operators and samples.
- Fully sealed tube prevents contamination of cells.

#### Efficient

- 4 independent channels work simultaneously for different tissue processing.
- Heating jackets are available for fully automated sample preparation.
- Capable of single-cell suspension and tissue homogenate.

### Technical Parameters:

Model	DSC-400
Sample volume	20-4000mg
Buffer volume	0.3-10mL
Speed	20-4000 rpm
Temperature	37°C
Channels	4
Operation method	Touch screen
Dimensions (W*D*H)	215*380*190 mm
Weight	~9.0 kg

### Order Information:

Cat No.	Product Description
DSC-400	Single cell suspension dissociator
SCT-25	Tissue processing tube(25pcs/box)
SCT-100	Tissue processing tube(100pcs/box)
DHTE-5001	High Activity Tumor Tissue Enzymatic Digestion Kit (Mouse)

► Consumables:



**Tissue Processing Tube**

- Ethylene oxide(EO) sterilized
- Independent packaging make it convenient for storage and use

**Order Information:**

Model	SCT-25	SCT-100
Sample volume	20-4000mg	
Buffer volume	0.3-10mL	
Dimensions	35*89mm	
Package	25pcs/box	100pcs/box



**Enzymatic Digestion Kit**

- Targeted optimization of enzymatic hydrolysis formula can ensure high cell viability
- Preserving cell surface epitopes leads to no effect for downstream experiments

**Order Information:**

Product Description	Model	Number of reactions
High Activity Tumor Tissue Enzymatic Digestion Kit (Mouse)	DHTE-5001	50T
High Activity Neonatal Brain Enzymatic Digestion Kit (Mouse and Rat)	DHNBE-5002	50T
High Activity Adult Brain Enzymatic Digestion Kit (Mouse and Rat)	DHABE-5003	50T
High Activity Spleen Tissue Enzymatic Digestion Kit (Mouse)	DHSE-5004	50T
Other Tissue Enzymatic Digestion Kit *		

**Cell Separation Kit**



HCSC-25 High-capacity separation column



Mouse CD3<sup>+</sup> Cell Separation Kit

► **Features**

- High cell viability, high purity, low stimulation, and low residue.
- Cell culture, flow cytometry, and single-cell sequencing can be carried out after separation.

**Order Information:**

Cat No.	Product Description
HCSC-25	High-capacity separation column(25pcs/box)
SSA	Separation stand
HCS-01	High-capacity Separator
K1301-10	Mouse CD3 <sup>+</sup> Cell Separation Kit

## CO<sub>2</sub> Incubator

### Provide a more stable cell culture environment

D180-P is a well-designed air-jacketed CO<sub>2</sub> incubator for all kinds of cell lines or tissues culture, including primary cells, stem cells, and so on.

It can provide a more suitable culture environment for cells by controlling temperature, CO<sub>2</sub> concentration precisely and by maintaining a high relative humidity (RH). The built-in 140°C dry-heat sterilization program helps to prevent bacterial contamination. All the data and 7-days performance trend graphing are visible on the 7-inch touch screen, and stored data can be download trough USB.

With reliable temperature stability, pure environment, and simple operation, D180-P will be an indispensable device in the fields of cancer research, stem cell research, immunology research, pharmaceutical research, and neurobiology research.

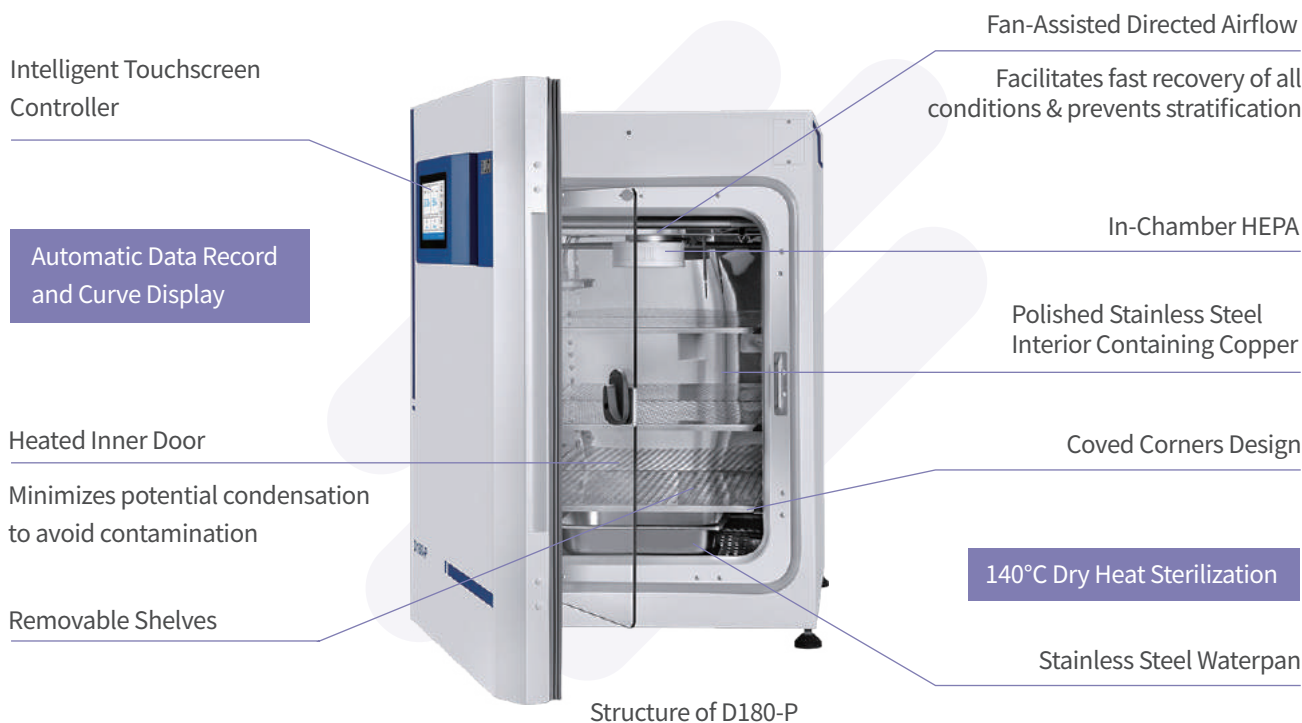

### Product characteristics

#### Stable environment for cell culture

- High temperature resistant infrared (IR) CO<sub>2</sub> sensor enables real-time monitoring the change of CO<sub>2</sub> concentration.
- Six-sided air jacketed heating method with Pt1000 platinum thermistor significantly shorten the recover time to target temperature.
- Standard humidity sensor monitors real-time humidity changes.

#### Contamination control of Inner chamber

- In-chamber HEPA filter combined with an active fan system provides ISO 5 (Class 100) air cleanliness.
- 140°C high temperature sterilization provides overnight cycle operation to eliminate potential contamination.

## Intelligent operation

- 7-inch touch screen provides complete data visibility including three core parameters (Temp. , CO<sub>2</sub> and rH) and alarm records to monitor incubator operation in real time.
- 8000 operation or alarm records ensure the safety of samples and incubator.
- Customized alarm settings allow users to modify upper and lower alarm limits.
- Within 7 days parameters curve display (Temp. , CO<sub>2</sub> and rH) provides real time monitoring.



High Efficiency Particulate Air Filter System



Stainless Steel Waterpan

## ► Technical Parameters

Temperature	Control & Range	±0.1°C, 5°C above ambient to 50°C
	Heating Method	Air Jackted
	Uniformity	±0.3°C @ 37°C
	Alarm Setting	±5°C
	Sensor	Pt1000 platinum thermistor
	Controller	PID
	Readability & Stability	0.1°C
CO <sub>2</sub> Concentration	Sterilization Method	140°C dry heat sterilization
	Control & Range	Better than ±0.1% ; 0-20%
	Sensor	High temperature resistant infrared (IR) sensor
	Inlet Pressure	1.0 bar (recommended)
	Uniformity	±0.3%
Humidity	Readability & Stability	0.10%
	Alarm Setting	±1%
	Humidity Pan Volume	~3.8 L
Shelves	Display	1% RH
	Dimensions	47.0×47.0 cm
Size & Weight	Surface Area (Standard & Max)	214.6 cm <sup>2</sup> ; 220.7 cm <sup>2</sup>
	Number (Standard & Max)	3 ; 16
	Interior Volume	175 L
Size & Weight	Interior Dimensions	51.0 (W) ×54.7 (D) ×67.5 (H) cm
	Exterior Dimensions	66.0 (W) ×67.0 (D) ×97.0 (H) cm
	Net Weight	110 kg (242.5 lbs)

## ► Order Information

Cat No.	Product Description
D180-P	CO <sub>2</sub> incubator (Equipped with humidity display and high temperature sterilization function), 220V-240V VAC 50/60 Hz
D181-P	CO <sub>2</sub> incubator (Equipped with humidity display and high temperature sterilization function), 120V-120V VAC 50/60 Hz

## Automated Cell Counters

RWD Automated Cell Counter adopts Trypan Blue staining method, intelligent image recognition and advanced optical imaging technology to achieve accurate and automatic cell analysis. The algorithm can identify both live and dead cells within 9 seconds. Information such as cell counts, viability, diameter can be obtained by just one-click. With fluorescence cube, C100 can display images in BF and FL channels simultaneously and clearly present cell counts and cell morphology. It is an optimal device to analyze cell viability and transfection efficiency in immunology and vaccine development, cell therapy, tumor research, stem cell, metabolism research and others.

BF



C100-SE Automated Cell Counter

FL



C100 Automated Cell Counter

### Product Characteristics

#### High accuracy

- The self-developed algorithm can identify clustered cells.
- Intelligently cell marks contribute to precise cell recognition.
- RBC counting.
- Low autofluorescence and high-transmit filter enable clear imaging.

#### Time-saving

- User-friendly UI and built-in user guide interfaces ensure easy operation.
- Up to 1000 counting results can be stored. No need another device for extra storage.

#### User-friendly

- Autofocus and auto exposure.
- Powerful computing capability ensures high efficiency.

#### Compact design

- Compact size fits into different placements.
- Removable modular FL cubes allow easy switches among various scenes.

### Accessories and consumables



Disposable Cell Counting Slide



FL Cube



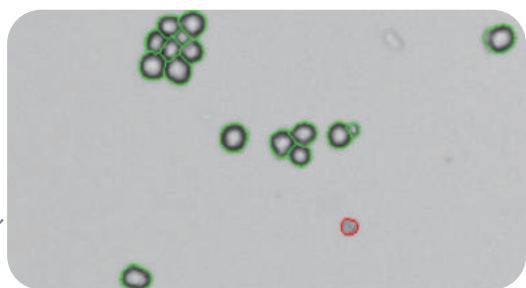

• Clustered cell recognition algorithm

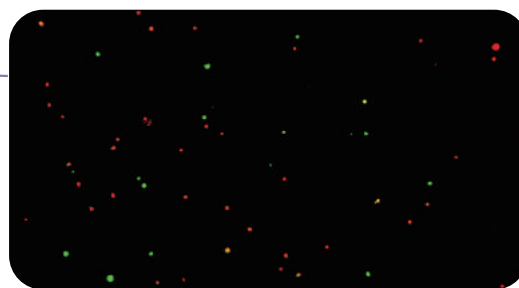

• Clear fluorescence imaging



• Pre-dilution calculator

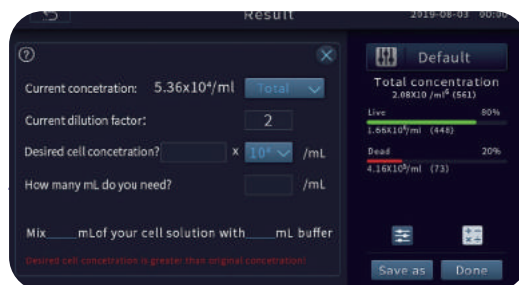

• Cell splitting calculator

## ▶ Technical Parameters

Parameters	Description
Model	C100-SE
Optional fluorescence application	C100
	● (Ex :375/28nm ;Em:460/50nm)
	● (Ex :480/30nm ;Em:535/40nm)
	● (Ex :540/25nm ;Em:620/60nm)
Amplification Factor	2.5×, 5.0 Megapixel
Focus Method	Manual focusing & Autofocusing
Counting Area	2.15 mm×1.62 mm
Cell Type	Cell lines, stem cells, primary cells, pollens, beer yeast
Cell Size Range	4-60 μm (Optimal: 7-60 μm)
Cell Concentration Range	10 <sup>4</sup> -10 <sup>7</sup> cells/mL
Cell counting Time	Less than 9s
Historical Data Storage	1000 counting reports and images at most
Languages	Chinese and English
Dimensions	212 mm(W)* 264 mm(H)* 165 mm (D)
Weight	~3.0kg
	~3.2kg

FL Cube	Excitation	Emission	General Dyes
FL Cube-01	375/28nm	460/50nm	DAPI, Hoechst, BFP
FL Cube-02	480/30nm	535/40nm	Acridine Orange (AO), Calcein-AM, Alexa fluor 488, SYBR Green, FITC, GFP
FL Cube-03	540/25nm	620/60nm	Propidium Iodide (PI), DsRed, dTomato, RFP

## Order Information

Cat No.	Product Description
C100-SE	Automated Cell Counter (BF)
C100	Automated Cell Counter (BF + FL)
FL Cube-01	● (Ex :375/28nm ;Em:460/50nm)
FL Cube-02	● (Ex :480/30nm ;Em:535/40nm)
FL Cube-03	● (Ex :540/25nm ;Em:620/60nm)
DS-50	Disposable Slide (50 pcs/box)

## Microcentrifuges

### M1324R Refrigerated Microcentrifuge

RWD M1324R microcentrifuge is a refrigerated model, it can work stably and quietly at the maximum speed of 15000rpm. Even at the highest speed, it will still make sure the stable temperature centrifugation of samples at -10°C~40°C. Optional rotors for different needs (PCR tubes, 1.5/2 mL EP tubes, etc.).

Small footprint and low noise, touch screen interaction, all your user-defined preset programs can be called by one click. All the functions are designed according to your needs, which simplifies centrifugation.



M1324R Microcentrifuge

### Product characteristics

#### Efficient

- Quick precooling. From RT to 4 °C in only 8 minutes.
- The seamlessly fit for inner cavity winding technology enables high-efficient energy transfer.

#### Stable and Safe

- High-density foaming technology benefits energy-saving and heat-preservation.
- Standard aerosol-tight rotor with aerospace-grade aluminum alloy withstands high temperature sterilization and avoids biohazards.
- Qualified ultrasonic non-destructive test, Schenck balancing test and extreme blasting test to protect personnel safety.
- Real-time rotor dynamic balancing monitoring system and multiple alarm functions guarantee safe operation.

#### Simple

- Combination of touch screen and function keys provides quick and convenient setting and parameter use.
- 12 custom programs enable immediate centrifuge operation in multiple scenarios.
- Magnetic condensed water collection pan to eliminate inner water accumulation.
- Mechanical lock design for the centrifuge lid enables easy opening and closing.
- Quick-Lock rotor, closes with only a 1/3 turn.

#### Compact

- One-pipette-width compact design.
- Lid hinge design with suspending hovering optionally.

Self-locking lid

Standard  
Aerosol-tight rotor

Combination of buttons  
and touch interaction

Small, quiet and durable

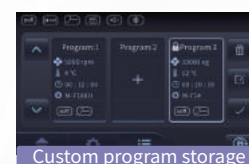
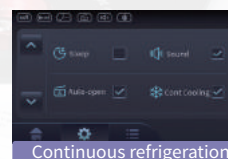
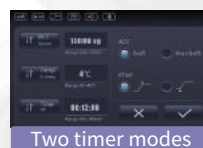

## ► Technical Parameters

Parameters	Description
Max. Speed	15000rpm
Max. RCF	21130×g
Max. Capacity	2mL×24
Display	Touch screen
Program	12
Temperature Control	-10°C to 40°C
Noise Level	<54dB (A)
Dimension (W*H*D)	304mm*304mm*517mm
Weight (with rotor)	33kg

## ► Order Information

Model	Product Description
M1324R	Microcentrifuge, Refrigerated, Rotor with Aerosol-tight lid
M-F24G	Aerosol-tight Lid, 24×1.5/2 mL tube rotor
M-F24	24×1.5/2 mL tube rotor
M-F4PCR	4×PCR tube rotor
M-F18Kit	18×Spin column rotor
M-F24QG	Aerosol-tight Lid, 24×1.5/2.0 mL tube Quick- Lock rotor
M-F24Q	24×1.5/2 mL tube Quick- Lock rotor

## M1324 Ventilated Microcentrifuge

RWD M1324 microcentrifuge is a ventilated model, it can satisfy most of common standard applications. And even at the highest speed, it can still work stably and quietly. It is the best choice for laboratory separation and provides great flexibility with its optional rotors for different needs (PCR tubes, 1.5/2 mL EP tubes, etc.).



M1324 Microcentrifuge



Quick-Lock rotor

- Max. speed 15,800 rpm
- Max. RCF 23,444×g
- 4.3-inch touch screen control
- Low noise and high-speed accuracy
- Multi-step speed up and down available (10 acceleration and braking ramps)
- Quick-Lock rotor, closes with only a 1/3 turn
- Automatic unbalance detection
- Self-locking device, over-speed safety device, and automatic alarm device
- Inching function with brief centrifuging

### ► Technical Parameters

Parameters	Description
Max. Speed	15800rpm (23444×g)
Max. Capacity	2mL×24
Noise Level	≤ 51dB(A)
Display	Touch screen
Program	48
Dimension (W*H*D)	262mm*282mm*385mm
Weight (with rotor)	22kg

### ► Order Information

Model	Product Description
M1324	Microcentrifuge, Ventilated, Rotor with Aerosol-tight lid
M-F24G	Aerosol-tight Lid, 24×1.5/2 mL tube rotor
M-F24	24×1.5/2 mL tube rotor
M-F4PCR	4×PCR tube rotor
M-F18Kit	18×Spin column rotor
M-F24QG	Aerosol-tight Lid, 24×1.5/2.0 mL tube Quick-lock rotor
M-F24Q	24×1.5/2 mL tube Quick-Lock rotor

# Animal Surgical Instrument & Matrices

RWD surgical instruments cover surgical scissors, surgical forceps, orthopedic instruments, scalpels and blades, vascular forceps, needle forceps, with more than 1,000 kinds of models.

## Surgery Instrument Kit

### SP0001-G General Surgery Instrument Kit for Rodents



Cat.No.	Product Description	Qty
S11001-08	VANNAS Spring Scissors (Triangular)-S/S Str/8*1.5mm/8cm	1
S11002-08	VANNAS Spring Scissors (Triangular)-S/S Cvd/8*1.5mm/8cm	1
S12009-11	IRIS-Fine Scissors (Round Type)-S/S Str/25*5.6mm/11.5cm	1
S12010-11	IRIS-Fine Scissors (Round Type)-S/S Cvd/23.5*6mm/11.5cm	1
S12005-10	IRIS-Fine Scissors (Round Type)-S/S Str/23*5mm/10.5cm	1
S12004-09	IRIS-Fine Scissors (Round Type)-S/S Cvd/24*4.6mm/9.5cm	1
F11001-11	Micro Forceps-Str, head length 30mm, Tip 0.2*0.12mm, 11cm	1
F11004-11	Micro Forceps-Cvd, head length 26.8mm, Tip 0.2*0.12mm, 11cm	1
F12010-10	Dressing Forceps-Str, Tip width 1.8mm, teeth length 15mm, 10.5cm	1
F12011-10	Dressing Forceps-Cvd, Tip width 1.9mm, teeth length 15mm, 10.5cm	1
F21001-12	HALSTED Artery Forceps-Str/23.5*1mm/12.5cm	2
F21002-12	HALSTED Artery Forceps-Cvd/24*1mm/12.5cm	2
F22002-10	HARTMAN Mosquito Forceps-Str/20*0.8mm/10.5cm	2
F22003-10	HARTMAN Mosquito Forceps-Cvd/20.8*1mm/10cm	2
F31047-12	OLSEN-HEGAR Needle Holders with Scissors-Str, 10*2.15mm/12cm	1
S13029-14	MAYO-STILLE Dissecting & Operating Scissors-B/B Str/37*9mm/14cm	1
S15001-11	SPENCER Ligature Scissors (Slender Type)-27*6mm/11cm	1
S21010-15	BOHLER Rongeurs (Double)-Light Cvd/2*19mm/15cm	1
S22004-11	Bone Cutters with Flat Blades (SGL)-15*6.8mm/11cm	1
S14014-12	Operating Scissors (Round Type)-S/S Str/37.6*8.5mm/12.5cm	1
S31011-01	11# Scalpel Blades (Box of 100pcs)	1
S32003-12	Scalpel Handles with Ruler 3# Solid-12.5cm	1
S33009-06	Scalpel Blade Remover-6.5cm	1
F13019-12	ADSON 1x2 Teeth Tissue Forceps, Tip width 1.8mm, 12cm	1
R21027-12	STEVENS Hooks, 1 Angled Tooth, 5mm depth, 12.5cm	1
R22009-01	ALM 4x4 Teeth Retractors-Blunt, 65mm Spread, 7.5cm	1
R22005-45	3x3 Teeth Retractors-Blunt, 30mm Spread, 5cm	1
R51003-11	Dual-end Micro Spatula w/tip W. 2mm x Thk. 0.3mm - Cvd/11cm	1
F35204-70	NA Nylon Sutures w/Needle-△3/8/2.5×5/30cm/7-0 (50/Box)	0.2
F35401-50	NA Terylene Sutures w/Needle-○3/8/3×10/90cm/5-0 (50/Box)	0.2
R31006-06	SS Micro Clamps-Cvd/L*W 6.6*1mm/17mm	5
R31005-06	SS Micro Clamps-Str/L*W 6*1mm/19mm	5
R34001-14	Clip Applicator for R31005- and R31006-Clamps-8.4*5mm/14cm	1
SP0001-P	Instrument Storage Portfolio	1

### SP0003-R Microsurgery Instrument Kit for Rat, Cat, Rabbit etc.



Cat.No.	Product Description	Qty
S12005-10	IRIS-Fine Scissors (Round Type)-S/S Str/23*5mm/10.5cm	1
S12010-11	IRIS-Fine Scissors (Round Type)-S/S Cvd/23.5*6mm/11.5cm	1
F31047-12	OLSEN-HEGAR Needle Holders with Scissors-Str, 10*2.15mm/12cm	1
F11001-11	Micro Forceps-Str, head length 30mm, Tip 0.2*0.12mm, 11cm	1
R31005-06	SS Micro Clamps-Str/L*W 6*1mm/19mm	5
R34001-14	Clip Applicator for R31005- and R31006-Clamps-8.4*5mm/14cm	1
S11001-08	VANNAS Spring Scissors (Triangular)-S/S Str/8*1.5mm/8cm	1
S11002-08	VANNAS Spring Scissors (Triangular)-S/S Cvd/8*1.5mm/8cm	1
F21001-12	HALSTED Artery Forceps-Str/23.5*1mm/12.5cm	1
F21002-12	HALSTED Artery Forceps-Cvd/24*1mm/12.5cm	1
F35401-50	NA Terylene Sutures w/Needle-○3/8/3×10/90cm/5-0 (50/Box)	0.2
S32003-12	11# Scalpel Blades (Box of 100pcs)	1
S31011-01	Scalpel Handles with Ruler 3# Solid-12.5cm	1
SP0001-P	Instrument Storage Portfolio	1

### SP0003-M Microsurgery Instrument Kit for Mice



Cat.No.	Product Description	Qty
S12005-10	IRIS-Fine Scissors (Round Type)-S/S Str/23*5mm/10.5cm	1
S12004-09	IRIS-Fine Scissors (Round Type)-S/S Cvd/24*4.6mm/9.5cm	1
F31047-12	OLSEN-HEGAR Needle Holders with Scissors-Str, 10*2.15mm/12cm	1
F11001-11	Micro Forceps-Str, head length 30mm, Tip 0.2*0.12mm, 11cm	1
R31005-04	SS Micro Clamps-Str/L*W 4*0.75mm/16mm	5
R34001-14	Clip Applicator for R31005- and R31006-Clamps-8.4*5mm/14cm	1
S11001-08	VANNAS Spring Scissors (Triangular)-S/S Str/8*1.5mm/8cm	1
S11002-08	VANNAS Spring Scissors (Triangular)-S/S Cvd/8*1.5mm/8cm	1
F22002-10	HARTMAN Mosquito Forceps-Str/20*0.8mm/10.5cm	1
F22003-10	HARTMAN Mosquito Forceps-Cvd/20.8*1mm/10cm	1
F35401-50	NA Terylene Sutures w/Needle-○3/8/3×10/90cm/5-0 (50/Box)	0.2
S32003-12	11# Scalpel Blades (Box of 100pcs)	1
S31011-01	Scalpel Handles with Ruler 3# Solid-12.5cm	1
SP0001-P	Instrument Storage Portfolio	1

**SP0005-R**  
**Brain Microinjection Surgery Instrument Kit for Rat**



Cat.No.	Product Description	Qty
S31011-01	Scalpel Handles with Ruler 3# Solid-12.5cm	1
S32003-12	11# Scalpel Blades (Box of 100pcs)	1
S12005-10	IRIS-Fine Scissors (Round Type)-S/S Str/23*5mm/10.5cm	1
S12006-10	IRIS-Fine Scissors (Round Type)-S/S Cvd/22*4.5mm/10.5cm	1
F12010-10	Dressing Forceps-Str, Tip width 1.8mm, teeth length 15mm, 10.5cm	2
F12011-10	Dressing Forceps-Cvd, Tip width 1.9mm, teeth length 15mm, 10.5cm	2
F21001-12	HALSTED Artery Forceps-Str/23.5*1mm/12.5cm	2
F21002-12	HALSTED Artery Forceps-Cvd/24*1mm/12.5cm	2
F31047-12	OLSEN-HEGAR Needle Holders with Scissors-Str, 10*2.15mm/12cm	1
S14014-12	Operating Scissors (Round Type)-S/S Str/37.6*8.5mm/12.5cm	1
F35204-70	HARTMAN Mosquito Forceps-Str/20*0.8mm/10.5cm	0.2
R22009-01	ALM 4x4 Teeth Retractors-Blunt, 65mm Spread, 7.5cm	1
R51003-11	Dual-end Micro Spatula w/tip W. 2mm x Thk. 0.3mm - Cvd/11cm	1
SP0001-P	Instrument Storage Portfolio	1

**SP0005-M**  
**Brain Microinjection Surgery Instrument Kit for Mice**



Cat.No.	Product Description	Qty
S31011-01	Scalpel Handles with Ruler 3# Solid-12.5cm	1
S32003-12	11# Scalpel Blades (Box of 100pcs)	1
S12005-10	IRIS-Fine Scissors (Round Type)-S/S Str/23*5mm/10.5cm	1
S12004-09	IRIS-Fine Scissors (Round Type)-S/S Cvd/24*4.6mm/9.5cm	1
S14014-10	Operating Scissors (Round Type)-S/S Str/32.7*8.45mm/10.5cm	1
F12005-10	IRIS Dissecting Forceps-Str, Tip width 1mm, teeth length 14mm, 10cm	2
F12006-10	IRIS Dissecting Forceps-Light Cvd, Tip width 1mm, teeth length 13.5mm, 10cm	2
F22002-10	HARTMAN Mosquito Forceps-Str/20*0.8mm/10.5cm	2
F31047-12	OLSEN-HEGAR Needle Holders with Scissors-Str, 10*2.15mm/12cm	1
F35204-70	HARTMAN Mosquito Forceps-Str/20*0.8mm/10.5cm	0.2
F22003-10	HARTMAN Mosquito Forceps-Cvd/20.8*1mm/10cm	2
R51003-11	Dual-end Micro Spatula w/tip W. 2mm x Thk. 0.3mm - Cvd/11cm	1
SP0001-P	Instrument Storage Portfolio	1

**SP0007-M**  
**Universal Dissecting Surgery Instrument Kit for Mice**



Cat.No.	Product Description	Qty
S12005-10	IRIS-Fine Scissors (Round Type)-S/S Str/23*5mm/10.5cm	1
S12004-09	IRIS-Fine Scissors (Round Type)-S/S Cvd/24*4.6mm/9.5cm	1
S13003-11	STEVENS Fine Dissecting Scissors (Flat Type)-B/B Str/25*4mm/11.5cm	1
S13004-11	STEVENS Fine Dissecting Scissors (Flat Type)-B/B Cvd/28*5mm/11.5cm	1
S15001-09	SPENCER Ligature Scissors (Slender Type)-20.3*4mm/9cm	1
S32003-12	11# Scalpel Blades (Box of 100pcs)	1
S31015-01	15# Scalpel Blades (Box of 100pcs)	1
F12005-10	IRIS Dissecting Forceps-Str, Tip width 1mm, teeth length 14mm, 10cm	2
F12006-10	IRIS Dissecting Forceps-Light Cvd, Tip width 1mm, teeth length 13.5mm, 10cm	2
F22002-10	HARTMAN Mosquito Forceps-Str/20*0.8mm/10.5cm	2
F22003-10	HARTMAN Mosquito Forceps-Cvd/20.8*1mm/10cm	2
F13029-10	IRIS 1x2 Teeth Tissue Forceps-Str, Tip width 1.3mm, 10.5cm	1
F31047-12	OLSEN-HEGAR Needle Holders with Scissors-Str, 10*2.15mm/12cm	1
F35401-50	NA Terylene Sutures w/Needle-○3/8/3×10/90cm/5-0 (50/Box)	0.2
R22005-45	3x3 Teeth Retractors-Blunt, 30mm Spread, 5cm	1
R31005-04	SS Micro Clamps-Str/L*W 4*0.75mm/16mm	5
R42002-12	Spinal Cord Hook - Tip Dia. 3mm/12cm	1
R34001-14	Clip Applicator for R31005- and R31006-Clamps-8.4*5mm/14cm	1
SP0001-P	Instrument Storage Portfolio	1

**SP0007-R**  
**Universal Dissecting Surgery Instrument Kit for Rat**



Cat.No.	Product Description	Qty
S12005-10	IRIS-Fine Scissors (Round Type)-S/S Str/23*5mm/10.5cm	1
S12006-10	IRIS-Fine Scissors (Round Type)-S/S Cvd/22*4.5mm/10.5cm	1
S12010-11	IRIS-Fine Scissors (Round Type)-S/S Cvd/23.5*6mm/11.5cm	1
S13005-14	METZENBAUM Dissecting Scissors (Round Type)-B/B Str/40*6.3mm/14.5cm	1
S13006-14	METZENBAUM Dissecting Scissors (Round Type)-B/B Cvd/44*7.5mm/14.5cm	1
F21001-12	HALSTED Artery Forceps-Str/23.5*1mm/12.5cm	2
F21002-12	HALSTED Artery Forceps-Cvd/24*1mm/12.5cm	2
F12010-10	Dressing Forceps-Str, Tip width 1.8mm, teeth length 15mm, 10.5cm	2
F12011-10	Dressing Forceps-Cvd, Tip width 1.9mm, teeth length 15mm, 10.5cm	2
F13029-10	IRIS 1x2 Teeth Tissue Forceps-Str, Tip width 1.3mm, 10.5cm	1
F31047-12	OLSEN-HEGAR Needle Holders with Scissors-Str, 10*2.15mm/12cm	0.2
S15001-11	SPENCER Ligature Scissors (Slender Type)-27*6mm/11cm	1
S32003-12	11# Scalpel Blades (Box of 100pcs)	1
S31015-01	15# Scalpel Blades (Box of 100pcs)	1
F35401-50	NA Terylene Sutures w/Needle-○3/8/3×10/90cm/5-0 (50/Box)	1
R22009-01	ALM 4x4 Teeth Retractors-Blunt, 65mm Spread, 7.5cm	1
R31005-06	SS Micro Clamps-Str/L*W 6*1mm/19mm	5
R42002-12	Spinal Cord Hook - Tip Dia. 3mm/12cm	1
R34001-14	Clip Applicator for R31005- and R31006-Clamps-8.4*5mm/14cm	1
SP0001-P	Instrument Storage Portfolio	1

**SP0008-M Cardio-cerebral Perfusion Surgery Instrument Kit for Mice**



Cat.No.	Product Description	Qty	Cat.No.	Product Description	Qty
S14014-11	Operating Scissors (Round Type)-S/S Str/32.7*8.45mm/10.5cm	1	F35204-70	HARTMAN Mosquito Forceps-Str/20*0.8mm/10.5cm	0.2
S12005-10	IRIS-Fine Scissors (Round Type)-S/S Str/23*5mm/10.5cm	1	R21027-12	STEVENS Hooks, 1 Angled Tooth , 5mm depth, 12.5cm	1
S11001-08	VANNAS Spring Scissors (Triangular)-S/S Str/8*1.5mm/8cm	1	R22005-45	3x3 Teeth Retractors-Blunt, 30mm Spread, 5cm	1
F12007-10	IRIS Dissecting Forceps-Large Cvd, Tip width 0.9mm, teeth length 10mm, 10cm	1	F31047-12	OLSEN-HEGAR Needle Holders with Scissors-Str, 10*2.15mm/12cm	1
F12010-09	Dressing Forceps-Str, Tip width 1.8mm, teeth length 13.5mm, 9.5cm	2	R31005-04	SS Micro Clamps-Str/L*W 4*0.75mm/16mm	5
F22002-10	HARTMAN Mosquito Forceps-Str/20*0.8mm/10.5cm	2	R34001-14	Clip Applicator for R31005- and R31006-Clamps-8.4*5mm/14cm	1
F22003-10	HARTMAN Mosquito Forceps-Cvd/20.8*1mm/10cm	2	R42002-12	Spinal Cord Hook - Tip Dia. 3mm/12cm	1
F35401-50	NA Terylene Sutures w/Needle-○3/8/3×10/90cm/5-0 (50/Box)	0.2	SP0001-P	Instrument Storage Portfolio	1

**SP0008-R**  
**Cardio-cerebral Perfusion Surgery Instrument Kit for Rat**

Cat.No.	Product Description	Qty
S14014-12	Operating Scissors (Round Type)-S/S Str/37.6*8.5mm/12.5cm	1
S12005-10	IRIS-Fine Scissors (Round Type)-S/S Str/23*5mm/10.5cm	1
S11002-08	VANNAS Spring Scissors (Triangular)-S/S Cvd/8*1.5mm/8cm	1
F12007-10	IRIS Dissecting Forceps-Large Cvd, Tip width 0.9mm, teeth length 10mm, 10cm	1
F12005-10	IRIS Dissecting Forceps-Str, Tip width 1mm, teeth length 14mm, 10cm	2
F21001-12	HALSTED Artery Forceps-Str/23.5*1mm/12.5cm	2
F21002-12	HALSTED Artery Forceps-Cvd/24*1mm/12.5cm	2
F35401-50	NA Terylene Sutures w/Needle-○3/8/3×10/90cm/5-0 (50/Box)	0.2
F35204-70	HARTMAN Mosquito Forceps-Str/20*0.8mm/10.5cm	0.2
R21027-12	STEVENS Hooks, 1 Angled Tooth , 5mm depth, 12.5cm	1
R22005-45	3x3 Teeth Retractors-Blunt, 30mm Spread, 5cm	1
F31047-12	OLSEN-HEGAR Needle Holders with Scissors-Str, 10*2.15mm/12cm	1
R31005-06	SS Micro Clamps-Str/L*W 6*1mm/19mm	5
R42002-12	Spinal Cord Hook - Tip Dia. 3mm/12cm	1
R34001-14	Clip Applicator for R31005- and R31006-Clamps-8.4*5mm/14cm	1
SP0001-P	Instrument Storage Portfolio	1

**SP0011-B MCAO**  
**Surgical Instrument Kit for Rat & Mice**

Cat.No.	Product Description	Qty
S32003-12	Scalpel Handles with Ruler 3# Solid-12.5cm	1
S31015-01	15# Scalpel Blades (Box of 100pcs)	1
S14014-15	Operating Scissors (Round Type)-S/S Str/48*10mm/15.5cm	1
S12005-10	IRIS-Fine Scissors (Round Type)-S/S Str/23*5mm/10.5cm	1
S12006-10	IRIS-Fine Scissors (Round Type)-S/S Cvd/22*4.5mm/10.5cm	1
F12005-10	IRIS Dissecting Forceps-Str, Tip width 1mm, teeth length 14mm, 10cm	1
F12006-10	IRIS Dissecting Forceps-Light Cvd, Tip width 1mm, teeth length 13.5mm, 10cm	1
F13029-10	IRIS 1x2 Teeth Tissue Forceps-Str, Tip width 1.3mm, 10.5cm	1
F13030-10	IRIS 1x2 Teeth Tissue Forceps-Light Cvd, Tip width 1.3mm, 10.5cm	1
R21013-01	MANNERFELT Hooks, 2 Teeth (7mm), Blunt, 15.5cm*	4
R31005-06	SS Micro Clamps-Str/L*W 6*1mm/19mm	5
F11028-13	Micro Forceps-Cvd, head length 38mm, Tip 0.1*0.06mm, 13cm	1
F11027-13	Micro Forceps-Str, head length 37.5mm, Tip 0.1*0.06mm, 13cm	1
F11003-13	Micro Forceps-45°Angled, head length 30mm, Tip 0.15*0.1mm, 13cm	1
F11002-11	Micro Forceps-Str, head length 36.5mm, Tip 0.15*0.1mm, 11cm	1
F22002-10	HARTMAN Mosquito Forceps-Str/20*0.8mm/10.5cm	1
F22003-10	HARTMAN Mosquito Forceps-Cvd/20.8*1mm/10cm	1
S11001-08	VANNAS Spring Scissors (Triangular)-S/S Str/8*1.5mm/8cm	1
F31047-14	OLSEN-HEGAR Needle Holders with Scissors-Str, 17.3*1.7mm/14cm	1
F35204-70	NA Nylon Sutures w/Needle-△3/8/2.5×5/30cm/7-0 (50/Box)	0.2
SP0001-P	Instrument Storage Portfolio	1

**SP0010-B Basic Surgical Instrument Kit for Rat & Mice**

Cat.No.	Product Description	Qty	Cat.No.	Product Description	Qty
S11001-08	VANNAS Spring Scissors (Triangular)-S/S Str/8*1.5mm/8cm	1	F22003-10	HARTMAN Mosquito Forceps-Cvd/20.8*1mm/10cm	1
S12005-10	IRIS-Fine Scissors (Round Type)-S/S Str/23*5mm/10.5cm	1	F31047-12	OLSEN-HEGAR Needle Holders with Scissors-Str, 10*2.15mm/12cm	1
F12005-10	IRIS Dissecting Forceps-Str, Tip width 1mm, teeth length 14mm, 10cm	1	S33007-12	ZIEGLER Knives-8mm Cutting Edge/1.5mm Width/12cm	1
F12006-10	IRIS Dissecting Forceps-Light Cvd, Tip width 1mm, teeth length 13.5mm, 10cm	1	R31005-06	SS Micro Clamps-Str/L*W 6*1mm/19mm	1
F11020-11	Micro Forceps-Str, head length 36mm, Tip 0.05*0.01mm, 11cm	1	R31006-06	SS Micro Clamps-Cvd/L*W 6.6*1mm/17mm	1
F22002-10	HARTMAN Mosquito Forceps-Str/20*0.8mm/10.5cm	1	SP0001-P	Instrument Storage Portfolio	1

**SP0009-R General Surgery Instrument Kit for Rat**

Cat.No.	Product Description	Qty
F11020-11	Micro Forceps-Str, head length 36mm, Tip 0.05*0.01mm, 11cm	1
F11021-11	Micro Forceps-45°Angled, head length 30mm, Tip 0.1*0.06mm, 11cm	1
S32003-12	Scalpel Handles with Ruler 3# Solid-12.5cm	1
S31011-01	11# Scalpel Blades (Box of 100pcs)	1
F35401-50	NA Terylene Sutures w/Needle-○3/8/3×10/90cm/5-0 (50/Box)	0.2
F35204-70	NA Nylon Sutures w/Needle-△3/8/2.5×5/30cm/7-0 (50/Box)	0.2
F31047-12	OLSEN-HEGAR Needle Holders with Scissors-Str, 10*2.15mm/12cm	1
S11001-08	VANNAS Spring Scissors (Triangular)-S/S Str/8*1.5mm/8cm	1
S11002-08	VANNAS Spring Scissors (Triangular)-S/S Cvd/8*1.5mm/8cm	1
R22009-01	ALM 4x4 Teeth Retractors-Blunt, 65mm Spread, 7.5cm	1
F12005-10	IRIS Dissecting Forceps-Str, Tip width 1mm, teeth length 14mm, 10cm	1
F12006-10	IRIS Dissecting Forceps-Light Cvd, Tip width 1mm, teeth length 13.5mm, 10cm	1
F12007-10	IRIS Dissecting Forceps-Large Cvd, Tip width 0.9mm, teeth length 10mm, 10cm	1
F13029-10	IRIS 1x2 Teeth Tissue Forceps-Str, Tip width 1.3mm, 10.5cm	1
S12009-11	IRIS-Fine Scissors (Round Type)-S/S Str/25*5.6mm/11.5cm	1
S12010-11	IRIS-Fine Scissors (Round Type)-S/S Cvd/23.5*6mm/11.5cm	1
F21001-12	HALSTED Artery Forceps-Str/23.5*1mm/12.5cm	1
F21002-12	HALSTED Artery Forceps-Cvd/24*1mm/12.5cm	1
SP0001-P	Instrument Storage Portfolio	1

**SP0009-M**  
**General Surgery Instrument Kit for Mouse**

Cat.No.	Product Description	Qty
F11020-11	Micro Forceps-Str, head length 36mm, Tip 0.05*0.01mm, 11cm	1
F11021-11	Micro Forceps-45°Angled, head length 30mm, Tip 0.1*0.06mm, 11cm	1
S32003-12	Scalpel Handles with Ruler 3# Solid-12.5cm	1
S31011-01	11# Scalpel Blades (Box of 100pcs)	1
F35401-50	NA Terylene Sutures w/Needle-○3/8/3×10/90cm/5-0 (50/Box)	0.2
F31047-12	OLSEN-HEGAR Needle Holders with Scissors-Str, 10*2.15mm/12cm	1
S11001-08	VANNAS Spring Scissors (Triangular)-S/S Str/8*1.5mm/8cm	1
S11002-08	VANNAS Spring Scissors (Triangular)-S/S Cvd/8*1.5mm/8cm	1
R22029-04	Colibri Eye Specula-15mm spread, 4cm	1
F12005-10	IRIS Dissecting Forceps-Str, Tip width 1mm, teeth length 14mm, 10cm	1
F12006-10	IRIS Dissecting Forceps-Light Cvd, Tip width 1mm, teeth length 13.5mm, 10cm	1
F12007-10	IRIS Dissecting Forceps-Large Cvd, Tip width 0.9mm, teeth length 10mm, 10cm	1
F13029-10	IRIS 1x2 Teeth Tissue Forceps-Str, Tip width 1.3mm, 10.5cm	1
S12005-10	IRIS-Fine Scissors (Round Type)-S/S Str/23*5mm/10.5cm	1
S12004-09	IRIS-Fine Scissors (Round Type)-S/S Cvd/24*4.6mm/9.5cm	1
F22002-10	HARTMAN Mosquito Forceps-Str/20*0.8mm/10.5cm	1
F22003-10	HARTMAN Mosquito Forceps-Cvd/20.8*1mm/10cm	1
SP0001-P	Instrument Storage Portfolio	1

# Micro Spring Scissors



**VANNAS Spring Scissors**

Cat.No.: S11001-08

- Triangular | Straight
- Sharp&Sharp
- Cutting Edge (Length): 8.0mm
- Width: 1.5mm | 8.0cm
- Price: \$99.00



Cat.No.: S11002-08

- Triangular | Curved
- Sharp&Sharp
- Cutting Edge (Length): 8.0mm
- Width: 1.5mm | 8.0cm
- Price: \$102.00



Cat.No.: S11003-08

- Triangular | Angled
- Sharp&Sharp
- Cutting Edge (Length): 6.3mm
- Width: 1.35mm | 8.0cm
- Price: \$106.00



**VANNAS Spring Scissors**

Cat.No.: S11035-08

- Triangular | Straight
- Sharp&Sharp
- Cutting Edge (Length): 3.5mm
- Width: 1.5mm | 8.0cm
- Price: \$92.00

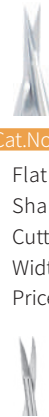

Cat.No.: S11036-08

- Flat | Straight
- Sharp&Sharp
- Cutting Edge (Length): 8.2mm
- Width: 1.5mm | 8.0cm
- Price: \$118.00



Cat.No.: S11037-08

- Flat | Curved
- Sharp&Sharp
- Cutting Edge (Length): 8.0mm
- Width: 1.5mm | 8.0cm
- Price: \$118.00



**VANNAS Spring Scissors**

Cat.No.: S11007-12

- Straight
- Sharp&Sharp
- Cutting Edge (Length): 19mm
- Width: 4.25mm | 12.5cm
- Price: \$45.5.00



Cat.No.: S11019-14

- Straight
- Sharp&Sharp
- Cutting Edge (Length): 14.5mm
- Width: 3.2mm | 14cm
- Price: \$121.00



Cat.No.: S11022-14

- Curved
- Sharp&Sharp
- Cutting Edge (Length): 14.5mm
- Width: 3.2mm | 14cm
- Price: \$94.00



**VANNAS Spring Scissors**

Cat.No.: S11014-12

- Straight
- Sharp&Sharp
- Cutting Edge (Length): 5.5mm
- Width: 1.9mm | 12.5cm
- Price: \$103.00



Cat.No.: S11008-12

- Curved
- Sharp&Sharp
- Cutting Edge (Length): 14mm
- Width: 0.2mm | 12cm
- Price: \$48.00



## Fine Scissors



Cat.No.: S12004-09

- Curved
- Sharp&Sharp
- Cutting Edge (Length): 24mm
- Width: 4.6mm | 9.5cm
- Price: \$25.00

### IRIS-Fine Fine Scissors

Cat.No.: S12003-09

- Straight
- Sharp&Sharp
- Cutting Edge (Length): 24.5mm
- Width: 5mm | 9cm
- Price: \$24.00



Cat.No.: S12005-10

- Straight
- Sharp&Sharp
- Cutting Edge (Length): 23mm
- Width: 5mm | 10.5cm
- Price: \$24.00



Cat.No.: S12006-10

- Curved
- Sharp&Sharp
- Cutting Edge (Length): 22mm
- Width: 4.5mm | 10.5cm
- Price: \$25.00



Cat.No.: S12011-12

- Straight
- Sharp&Sharp
- Cutting Edge (Length): 31mm
- Width: 5.8mm | 12.5cm
- Price: \$24.00



Cat.No.: S18005-10

- Straight
- Sharp&Sharp
- Cutting Edge (Length): 20.5mm
- Width: 5mm | 10.5cm
- Price: \$57.00



Cat.No.: S18005-09

- Straight
- Sharp&Sharp
- Cutting Edge (Length): 20.5mm
- Width: 4.5mm | 9cm
- Price: \$56.00



Cat.No.: S18002-10

- Curved
- Sharp&Sharp
- Cutting Edge (Length): 21.5mm
- Width: 5mm | 9cm
- Price: \$19.00



Cat.No.: S18002-10

- Curved
- Sharp&Sharp
- Cutting Edge (Length): 23mm
- Width: 5mm | 10cm
- Price: \$22.80



Cat.No.: S18004-11

- Curved
- Sharp&Sharp
- Cutting Edge (Length): 22mm
- Width: 5mm | 11.5cm
- Price: \$31.00



Cat.No.: S18004-10

- Curved
- Sharp&Sharp
- Cutting Edge (Length): 20mm
- Width: 5mm | 10.5cm
- Price: \$36.00

### IRIS Fine Scissors

Cat.No.: S12010-11

- Curved
- Sharp&Sharp
- Cutting Edge (Length): 23.5mm
- Width: 6mm | 11.5cm
- Price: \$25.00



Cat.No.: S12031-11

- Full Curved
- Sharp&Sharp
- Cutting Edge (Length): 29mm
- Width: 6mm | 1.5cm
- Price: \$14.50

### Fine Scissors

Cat.No.: S12034-12

- Straight
- Sharp&Sharp
- Cutting Edge (Length): 17mm
- Width: 6mm | 12.5cm
- Price: \$12.50

# Dissecting & Operating Scissors

Cat.No.:S13020-11

- Straight
- Sharp&Sharp
- Cutting Edge (Length):20mm
- Width:5mm | 12cm
- Price:\$24.00

Cat.No.:S13005-14

- Straight
- Blunt&Blunt
- Cutting Edge (Length):40mm
- Width:6.3mm | 14.5cm
- Price:\$24.00

Cat.No.:S13035-16

- Straight
- Blunt&Blunt
- Cutting Edge (Length):45mm
- Width:9.5mm | 16.5cm
- Price:\$31.00



### Delicate Scissors

Cat.No.:S13001-10

- Straight
- Blunt&Blunt
- Cutting Edge (Length):25.5mm
- Width:6mm | 10cm
- Price:\$28.00

Cat.No.:S14001-13

- Straight
- Sharp&Blunt
- Cutting Edge (Length):40.5mm
- Width:9.4mm | 13cm
- Price:\$17.00

Cat.No.:S14001-15

- Straight
- Sharp&Blunt
- Cutting Edge (Length):50mm
- Width:10mm | 15.5cm
- Price:\$19.00



### Operating Scissors

Cat.No.:S14001-10

- Straight
- Sharp&Blunt
- Cutting Edge (Length):33mm
- Width:7.5mm | 10.5cm
- Price:\$14.90

Cat.No.:S14014-12

- Straight
- Sharp&Sharp
- Cutting Edge (Length):37.6mm
- Width:8.5mm | 12.5cm
- Price:\$17.00

Cat.No.:S14014-13

- Straight
- Sharp&Sharp
- Cutting Edge (Length):45mm
- Width:9.8mm | 13cm
- Price:\$18.00

Cat.No.:S14014-15

- Straight
- Sharp&Sharp
- Cutting Edge (Length):48mm
- Width:10mm | 15.5cm
- Price:\$21.00



### Operating Scissors

Cat.No.:S14014-10

- Straight
- Sharp&Sharp
- Cutting Edge (Length):32.7mm
- Width:8.45mm | 10.5cm
- Price:\$14.30

Cat.No.:S14015-11

- Straight
- Blunt&Blunt
- Cutting Edge (Length):36mm
- Width:7mm | 11.5cm
- Price:\$14.30

Cat.No.:S14015-12

- Straight
- Blunt&Blunt
- Cutting Edge (Length):37mm
- Width:7mm | 12.5cm
- Price:\$14.30

Cat.No.:S14015-14

- Straight
- Blunt&Blunt
- Cutting Edge (Length):46mm
- Width:7.5mm | 14.5cm
- Price:\$17.00

Cat.No.:S14015-16

- Straight
- Blunt&Blunt
- Cutting Edge (Length):54mm
- Width:9mm | 16.5cm
- Price:\$19.00



### Operating Scissors

Cat.No.:S14015-10

- Straight
- Blunt&Blunt
- Cutting Edge (Length):35mm
- Width:7.5mm | 10.5cm
- Price:\$13.40

## Specialist Scissors & Bone Cutters & Rongeurs



### Stitch Scissors

Cat.No.: S15006-09

- Angled
- Sharp&Blunt
- Cutting Edge (Length):13.5mm
- Width:4mm | 9.5cm
- Price:\$30.00



Cat.No.: S15001-09

- Slender Type
- Cutting Edge (Length):20.3mm
- Width:4mm | 9cm
- Price:\$21.00



### BEEBE Bone Cutters

Cat.No.: S16001-10

- Straight
- Cutting Edge (Length):21mm
- Width:10mm | 10.5cm
- Price:\$10.00

### SPENCER Ligature Scissors

Cat.No.: S15001-11

- Slender Type
- Cutting Edge (Length):27mm
- Width:6mm | 11cm
- Price:\$24.00



Cat.No.: S22004-11

- Flat Blades
- Cutting Edge (Length):15mm
- Width:6.8mm | 11cm
- Price:\$46.00



Cat.No.: S21020-14

- Straight
- Cutting Edge (Length):0.7mm
- Width:6mm | 14.5cm
- Price:\$96.50



Cat.No.: S21021-14

- Straight
- Cutting Edge (Length):1mm
- Width:6.5mm | 14cm
- Price:\$85.00



Cat.No.: S21023-14

- Curved
- Cutting Edge (Length):0.7mm
- Width:7mm | 14cm
- Price:\$200.00



### BEEBE Bone Cutters

Cat.No.: S22005-12

- Flat Blades
- Cutting Edge (Length):15.2mm
- Width:7.4mm | 12.5cm
- Price:\$23.50



Cat.No.: S21024-14

- Curved
- Cutting Edge (Length):1mm
- Width:6.5mm | 14cm
- Price:\$88.00

### Rongeurs

Cat.No.: S21019-14

- Straight
- Cutting Edge (Length):0.5mm
- Width:7.5mm | 14.5cm
- Price:\$101.50

# Scalpel & Micro Forceps



### Scalpel

Cat.No.: S33006-13

- Straight
- Cutting Edge (Length): 25mm
- Width: 3mm | 13cm
- Price: \$33.00



### Scalpel Handles(3#)

Cat.No.: S32003-12

- 12.5cm
- Price: \$12.30



### Scalpel Handles(4#)

Cat.No.: S32004-13

- 14cm
- Price: \$8.90



### Scalpel Blades(10#)

Cat.No.: S31010-01

- Box of 100pcs
- Price: \$25.00



### Scalpel Blades(11#)

Cat.No.: S31011-01

- Box of 100pcs
- Price: \$25.00



### Scalpel Blades(12#)

Cat.No.: S31012-01

- Box of 100pcs
- Price: \$25.00



### Scalpel Blades(15#)

Cat.No.: S31015-01

- Box of 100pcs
- Price: \$25.00



### Micro Forceps

Cat.No.: F11029-11

- Straight
- Tips: 0.14mm x 0.09mm | 11cm
- Price: \$44.00



### Micro Forceps

Cat.No.: F11030-11

- 45° Angled
- Tips: 0.1mm x 0.06mm | 11cm
- Price: \$55.00



### Micro Forceps

Cat.No.: F11031-11

- Curved
- Tips: 0.07mm x 0.03mm | 11cm
- Price: \$53.00



### Micro Forceps

Cat.No.: F11001-11

- Straight
- Tips: 0.2mm x 0.12mm | 11cm
- Price: \$24.00



Cat.No.: F11002-11

- Straight
- Tips: 0.15mm x 0.1mm | 11cm
- Price: \$25.00



Cat.No.: F11020-11

- Straight
- Tips: 0.05mm x 0.01mm | 11cm
- Price: \$37.00



Cat.No.: F11003-13

- 45° Angled
- Tips: 0.15mm x 0.1mm | 13cm
- Price: \$33.00

Cat.No.: F11021-11

- 45° Angled
- Tips: 0.1mm x 0.06mm | 11cm
- Price: \$44.00

**Micro Forceps**

Cat.No.: F11003-11

- 45° Angled
- Tips: 0.3mm x 0.15mm | 11cm
- Price: \$29.00



Cat.No.: F13004-11

- Curved
- Tips: 0.3mm x 0.15mm | 11.5cm
- Price: \$29.00

Cat.No.: F11004-11

- Curved
- Tips: 0.2mm x 0.12mm | 11cm
- Price: \$32.00

**Micro Forceps**

Cat.No.: F11022-11

- Curved
- Tips: 0.1mm x 0.06mm | 11.5cm
- Price: \$42.00



Cat.No.: F11027-13

- Straight
- Tips: 0.1mm x 0.06mm | 13cm
- Price: \$90.00

**Micro Forceps**

Cat.No.: F11027-13

- Straight
- Tips: 0.1mm x 0.06mm | 13cm
- Price: \$90.00

## Surgical Forceps



Cat.No.: F12003-12

- Straight
- Tips width: 1.5mm | 12cm
- Price: \$22.00

Cat.No.: F13029-10

- Straight
- Tips width: 1.3mm | 10.5cm
- Price: \$28.00

Cat.No.: F13030-10

- Curved
- Tips width: 1.3mm | 10.5cm
- Price: \$30.00

Cat.No.: F13009-11

- Straight
- Tips width: 1.6mm | 11cm
- Price: \$65.00

**ADSON Dressing Forceps**

Cat.No.: F12002-12

- Straight
- Tips width: 0.6mm | 11cm
- Price: \$22.00

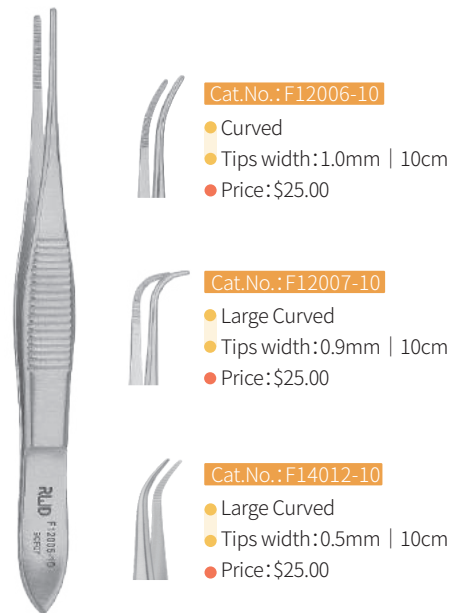

Cat.No.: F12006-10

- Curved
- Tips width: 1.0mm | 10cm
- Price: \$25.00

Cat.No.: F12007-10

- Large Curved
- Tips width: 0.9mm | 10cm
- Price: \$25.00

Cat.No.: F14012-10

- Large Curved
- Tips width: 0.5mm | 10cm
- Price: \$25.00

**IRIS Dissecting Forceps**

Cat.No.: F12005-10

- Straight
- Tips width: 1.0mm | 10cm
- Price: \$23.00



**McPHERSON Forceps**

Cat.No.: F18011-09

- Straight | 5mm Platform
- Tips: 0.4 x 0.9mm | 9cm
- Price: \$53.00

# Artery Forceps & Needle Holders

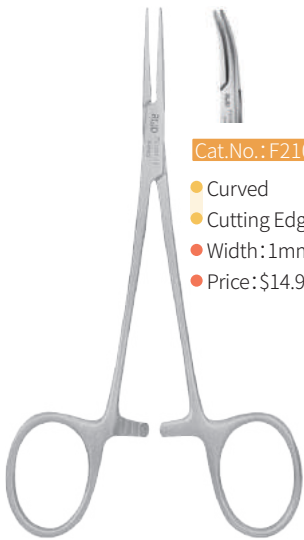

Cat.No.: F21002-12

- Curved
- Cutting Edge (Length): 24mm
- Width: 1mm | 12.5cm
- Price: \$14.90

## Artery Forceps

Cat.No.: F21001-12

- Straight
- Cutting Edge (Length): 23.5mm
- Width: 1mm | 12.5cm
- Price: \$14.30



Cat.No.: F18001-10

- Angled
- Head Width : 5.4mm | 10.5cm
- Price: \$19.00

## Cover Glass Forceps

Cat.No.: F18015-10

- Angled
- Head Width: 6mm | 10.6cm
- Price: \$14.90



Cat.No.: F22003-10

- Curved
- Cutting Edge (Length): 20.8mm
- Width: 1mm | 10cm
- Price: \$18.00

Cat.No.: F22010-12

- Straight
- Head Width : 0.6mm | 12.5cm
- Price: \$14.00

Cat.No.: F22002-10

- Straight
- Cutting Edge (Length): 20mm
- Width: 0.8mm | 10.5cm
- Price: \$17.00

## Artery Forceps

Cat.No.: F22011-12

- Curved
- Head Width : 0.6mm | 12.5cm
- Price: \$30.00



Cat.No.: F31047-14

- Straight | with Scissors
- Cutting Edge (Length): 17.3mm
- Width: 1.7mm | 14cm
- Price: \$49.00

## Needle Holders

Cat.No.: F31047-12

- Straight | with Scissors
- Cutting Edge (Length): 10mm
- Width: 2.15mm | 12cm
- Price: \$46.00



## BARRAQUER Needle Holders

Cat.No.: F31017-12

- Straight | saws & lock
- Cutting Edge (Length): 10mm
- Width: 0.9mm | 12cm
- Price: \$96.00

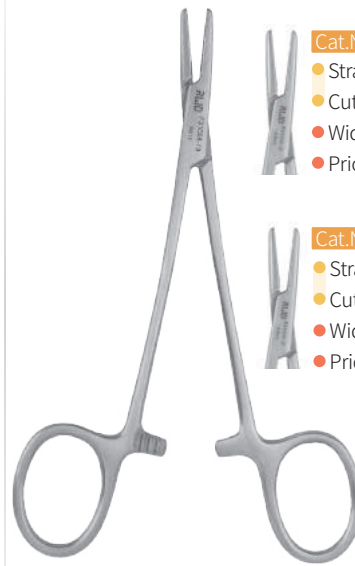

Cat.No.: F31034-12

- Straight
- Cutting Edge (Length): 15.2mm
- Width: 1.75mm | 13cm
- Price: \$23.00

Cat.No.: F31034-14

- Straight
- Cutting Edge (Length): 17.5mm
- Width: 1.75mm | 14cm
- Price: \$24.00

## Needle Holders

Cat.No.: F31025-13

- Straight
- Cutting Edge (Length): 17.5mm
- Width: 1.75mm | 13cm
- Price: \$23.00

## Ear Punch & Micro Clamps



Cat.No.: C22002-10

- Straight
- Punch Dia. :2mm | 10.5cm
- Price:\$35.00

### Ear Punch

Cat.No.: C22001-10

- Straight
- Punch Dia. :1mm | 10.5cm
- Price:\$35.00



### Micro Clamps

Cat.No.: R34001-14

- Straight
- Cutting Edge (Length):8.4mm
- Width:5mm | 14cm
- Price:\$41.00



Cat.No.: R31005-04

- Straight
- Cutting Edge (Length):4mm
- Width:0.75mm | 16mm
- Price:\$36.00



Cat.No.: R31005-06

- Straight
- Cutting Edge (Length):6mm
- Width:1.0mm | 19mm
- Price:\$36.00



Cat.No.: R31005-08

- Straight
- Cutting Edge (Length):8mm
- Width:2.0mm | 18mm
- Price:\$36.00



Cat.No.: R31005-10

- Straight
- Cutting Edge (Length):10mm
- Width:2.0mm | 20mm
- Price:\$36.00



Cat.No.: R31006-04

- Curved
- Cutting Edge (Length):6.3mm
- Width:1.0mm | 17mm
- Price:\$45.00



Cat.No.: R31006-06

- Curved
- Cutting Edge (Length):6.6mm
- Width:1.0mm | 17mm
- Price:\$45.00

The vascular clip of the R31005 and R31006 series must be used with the R34001-14 vascular clip holder

## Hooks&Retractors



### Hooks

Cat.No.: R21027-12

- 1 Angled Tooth
- 5mm depth | 12.5cm
- Price:\$19.00



### Retractors

Cat.No.: R22029-03

- 15mm spread | 3cm
- Price:\$19.00



### Retractors

Cat.No.: R22005-45

- 30mm Spread | 5cm
- Price:\$36.00



### Retractors

Cat.No.: R22011-50

- 30mm Spread | 5.5cm
- Price:\$45.00



### Retractors

Cat.No.: R22012-45

- 22mm Spread | 4.5cm
- Price:\$17.00

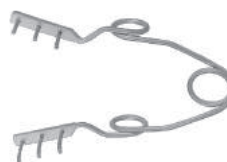

### Retractors

Cat.No.: R22006-55

- 36mm Spread | 5.5cm
- Price:\$38.00



### Retractors

Cat.No.: R22030-03

- 20.5mm Spread | 3cm
- Price:\$130.00

## Tying Forceps



### Tying Forceps

Cat.No.:FC11001R-11

- Straight(SS)
- Tips:0.3x0.5mm | 11cm
- Price:\$82.00



### Tying Forceps

Cat.No.:FC11002R-08

- Straight(SS)
- Tips:0.3x0.5mm | 8.5cm
- Price:\$70.00



### Tying Forceps

Cat.No.:FC11001T-11

- Straight(TA)
- Tips:0.3x0.5mm | 11cm
- Price:\$89.00



### Tying Forceps

Cat.No.:FC11002T-08

- Straight(TA)
- Tips:0.3x0.5mm | 8.5cm
- Price:\$77.00

## Corneal Forceps



### Corneal Forceps

Cat.No.:FC12001T-11

- Straight(TA)
- Tips:28mmx0.3mm | 10.7cm
- Price:\$122.00



### Corneal Forceps

Cat.No.:FC12002R-08

- Straight(SS)
- Tips:28mmx0.3mm | 8.5cm
- Price:\$81.00



### Corneal Forceps

Cat.No.:FC12001R-11

- Straight(SS)
- Tips:28mmx0.3mm | 10.7cm
- Price:\$108.00



### Corneal Forceps

Cat.No.:FC12002T-08

- Curved(TA)
- Tips:28mmx0.3mm | 8.5cm
- Price:\$96.00



## Tissue Forceps



### Tissue Forceps

Cat.No.:FC13002R-08

- Straight(SS)
- Tips:0.3x0.5mm | 8.5cm
- Price:\$104.00



### Tissue Forceps

Cat.No.:FC13001T-11

- Straight(TA)
- Tips:0.3x0.5mm | 10.7cm
- Price:\$135.00



### Tissue Forceps

Cat.No.:FC13001R-11

- Straight(SS)
- Tips:0.3x0.5mm | 10.7cm
- Price:\$122.00



### Tissue Forceps

Cat.No.:FC13002T-08

- Straight(TA)
- Tips:0.3x0.5mm | 8.5cm
- Price:\$113.00

## Capsulorhexis Forceps & Cataract Scissors



### Capsulorhexis Forceps

Cat.No.:FC14001T-11

- Curved(TA)
- Tips:0.6x0.6mm | 11cm
- Price:\$162.00



### Capsulorhexis Forceps

Cat.No.:FC14001R-11

- Curved(SS)
- Tips:0.6x0.6mm | 11cm
- Price:\$162.00



### Cataract Scissors

Cat.No.:SC12001R-13

- Straight(SS)
- Tips:19x1mm | 13cm
- Price:\$139.00



### Cataract Scissors

Cat.No.:SC12002R-13

- Curved(SS)
- Tips:19x1mm | 13cm
- Price:\$139.00

## Corneal/Conjunctival Scissors



Cat.No.: SC11001R-12

- Curved(SS)
- Sharp&Sharp
- Cutting Edge (Length): 15mm
- Width: 3mm | 12cm
- Price: \$138.00

### Corneal/Conjunctival Scissors

Cat.No.: SC11002R-11

- Curved(SS)
- Sharp&Sharp
- Cutting Edge (Length): 11mm
- Width: 3mm | 11cm
- Price: \$122.00



### Corneal/Conjunctival Scissors

Cat.No.: SC11001T-12

- Curved(TA)
- Sharp&Sharp
- Cutting Edge (Length): 15mm
- Width: 3mm | 12cm
- Price: \$156.00



### Corneal/Conjunctival Scissors

Cat.No.: SC11002T-11

- Curved(TA)
- Sharp&Sharp
- Cutting Edge (Length): 11mm
- Width: 3mm | 11cm
- Price: \$137.00



### Ear Tag applicator

Cat.No.: C23001-14

- Straight
- Punch Dia. : 2.55mm | 14.5cm
- Width: 3mm | 11cm
- Price: \$41.00



### Ear Tag

Cat.No.: 23001-5

- Black numbers A1-A500
- Price: \$112.00

## Glass Bead Sterilizer

The sterilizer provides a safe, convenient and affective method for sterilizing your surgical instruments before and during surgery, ensuring the tools free of pathogens and microbial contaminants. The highest temperature can reach 300 °C. The surgical instrument could sterilized completed Within 5 seconds.

### Ordering Information:

Model	Products Description	Price
RS1501	150g Glass Bead Sterilizer-4x8cm(110V)	\$429.00
RS1502	150g Glass Bead Sterilizer-4x8cm(220V)	\$429.00
RS3001	300g Glass Bead Sterilizer-4x14cm(110V)	\$514.00
RS3002	300g Glass Bead Sterilizer-4x14cm(220V)	\$514.00
RS1500	Glass Beads for Sterilizer, 1500g	\$40.00



## Sterilization Trays

### Sterilization Trays

Cat.No.: C12006-01

- Plastic
- Width: 270x160x22mm
- Price: \$70.00

### Sterilization Trays

Cat.No.: C12006-02

- Plastic
- Width: 215x135x22mm
- Price: \$58.00

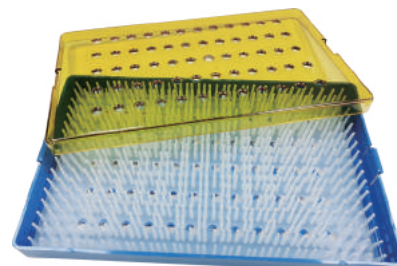

## Brain & Heart Matrices

RWD Brain and Heart matrices is made of stainless steel, electroless plating, through precision machining and highly polished, strong durability, which can be heated, chilled, autoclaved scrubbed and use in variety of harsh conditions. The surface will not be damaged by thermal pressure, and will not be damaged by mechanical impact, keeping the product in use for a long time.

Brain matrices have coronal sections and sagittal sections, each section can be as 0.5 mm or 1 mm. Widely use in preparing pathological tissue section and cut out TTC dyeing organization.



### Order Information:

Model	Product Description	A (mm)	B (mm)	C (mm)	D (mm)	E (mm)	Depth (mm)	Diagram
68707	Brain Matrix, Mouse 40-75g, Coronal, 1mm, Stainless steel	3.18	11.1	8.73	19.1	12.5	7.40	
68708	Brain Matrix, Mouse 40-75g, Sagittal, 1mm, Stainless steel	3.18	11.1	8.73	19.1	12.5	7.40	
68709	Brain Matrix, Rat, 175-300g, Coronal, 1mm, Stainless steel	4.76	17.9	14.7	36.6	27.35	8.94	
68710	Brain Matrix, Rat, 175-300g, Sagittal, 1mm, Stainless steel	4.76	17.9	14.7	36.6	27.35	8.94	
68711	Brain Matrix, Rat, 300-600g, Coronal, 1mm, Stainless steel	4.76	19.8	14.7	36.6	25.7	10.91	
68712	Brain Matrix, Rat, 300-600g, Sagittal, 1mm, Stainless steel	4.76	19.8	14.7	36.6	25.7	10.91	
68713	Brain Matrix, Mouse, 40-75g, Coronal, 0.5mm, Stainless steel	3.18	11.1	8.73	19.1	12.5	7.40	
68714	Brain Matrix, Mouse, 40-75g, Sagittal, 0.5mm, Stainless steel	3.18	11.1	8.73	19.1	12.5	7.40	
68715	Brain Matrix, Rat, 175-300g, Coronal, 0.5mm, Stainless steel	4.76	17.9	14.7	36.6	27.35	8.94	
68716	Brain Matrix, Rat, 175-300g, Sagittal, 0.5mm, Stainless steel	4.76	17.9	14.7	36.6	27.35	8.94	
68717	Brain Matrix, Rat, 300-600g, Coronal, 0.5mm, Stainless steel	4.76	19.8	14.7	36.6	25.7	10.91	
68718	Brain Matrix, Rat, 300-600g, Sagittal, 0.5mm, Stainless steel	4.76	19.8	14.7	36.6	25.7	10.91	
68719	Heart Matrix, Mouse 20-75g, Coronal, 1mm, Stainless steel	8.3	12.7	—	—	—	4.8	
68720	Heart Matrix, Rat 175-400g, Sagittal, 1mm, Stainless steel	12.7	19.9	—	—	—	9.6	
68721	Heart Matrix, Mouse 20-75g, Coronal, 0.5mm, Stainless steel	8.3	12.7	—	—	—	4.8	
68722	Heart Matrix, Rat 175-400g, Sagittal, 0.5mm, Stainless steel	12.7	19.9	—	—	—	9.6	

## MCAO Sutures

RWD MCAO suture utilizes high-quality nylon thread to induce ischemic stroke model. The within-group variation of stroke models can be maximally reduced by the super smooth surface and evenness of RWD suture. And without rupturing the vesicle, RWD suture makes its insertion into the animal brain much easier. The stability is also greatly increased for the cerebral ischemia modeling and more consistent data. RWD sutures are available in nylon monofilament material, diameters of silicone-rubber coated part range from 0.19mm to 0.44mm; Length of suture from 2-3cm.

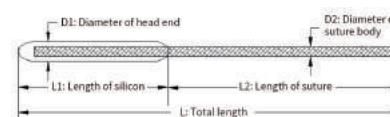
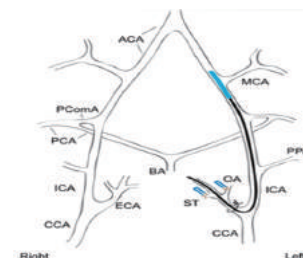
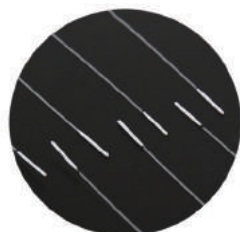

### ► Features

- It adopts high-quality nylon thread with very good flexibility, not easy to puncture blood vessels, which increase the success of stroke model development.
  - Ensure high uniformity and stability of the MCAO model.
  - Silicone-rubber coated in tip, greatly reduce the risk of puncturing blood vessels.
  - The line is marked with black dots, increased the observability during plugging into the blood vessel.
  - The new manufacturing process makes the sutures lighter and easier to use. The success rate of model making is higher and it is more suitable for long-term experiment.
- L1 in mouse suture: 3~4mm
  - L1 in rat suture: 5~6mm
  - L1 could be customized: 2~8mm

### Order Information:

Model	Diameter of Head end (mm)	Silicone head length (mm)	Diameter of suture body (mm)	Total Length (mm)	Animal's weight (g)	Packing (pcs)
MSMC19B007PK50	0.17~0.19	3~4	0.07	30	15~20g	50
MSMC19B008PK50	0.17~0.19	3~4	0.08	30	15~20g	50
MSMC19B100PK50	0.17~0.19	3~4	0.1	30	15~20g	50
MSMC21B007PK50	0.20~0.21	3~4	0.07	30	21~25g	50
MSMC21B008PK50	0.20~0.21	3~4	0.08	30	21~25g	50
MSMC21B100PK50	0.20~0.21	3~4	0.1	30	21~25g	50
MSMC21B120PK50	0.20~0.21	3~4	0.12	30	21~25g	50
MSMC23B007PK50	0.22~0.23	3~4	0.07	30	26~30g	50
MSMC23B008PK50	0.22~0.23	3~4	0.08	30	26~30g	50
MSMC23B100PK50	0.22~0.23	3~4	0.1	30	26~30g	50
MSMC23B120PK50	0.22~0.23	3~4	0.12	30	26~30g	50
MSMC25B120PK50	0.24~0.25	3~4	0.12	30	31~35g	50
MSMC25B150PK50	0.24~0.25	3~4	0.15	30	31~35g	50
MSMC26B150PK50	0.25~0.26	3~4	0.15	30	>35g	50
MSRC32B200PK50	0.31~0.32	5~6	0.2	50	<200g	50
MSRC35B200PK50	0.33~0.35	5~6	0.2	50	200~250g	50
MSRC37B200PK50	0.36~0.37	5~6	0.2	50	251~280g	50
MSRC40B200PK50	0.38~0.40	5~6	0.2	50	281~330g	50
MSRC42B200PK50	0.41~0.42	5~6	0.2	50	331~400g	50
MSRC45B200PK50	0.43~0.45	5~6	0.2	50	>400g	50

**Copyright ©RWD Life Science Co., LTD. 2021. All rights reserved.**

No part of this document maybe reproduced or transmitted in any form or by any means without prior written consent of RWD Life Science Co., LTD.

#### **Trademark Notice**

**RWD**, **RWD**瑞沃德, and **RWD**瑞沃德 are trademarks or registered trademarks of RWD Life Science Co., LTD.

Other trademarks, product, service and company names mentioned are the property of their respective owners.

#### **General Disclaimer**

The information in this document may contain predictive statements including, without limitation, statements regarding the future financial and operating results, future product portfolio, new technology, etc. There are a number of factors that could cause actual results and developments to differ materially from those expressed or implied in the predictive statements. Therefore, such information is provided for reference purpose only and constitutes neither an offer nor an acceptance.

RWD may change the information at any time without notice.

[www.rwdstco.com](http://www.rwdstco.com)

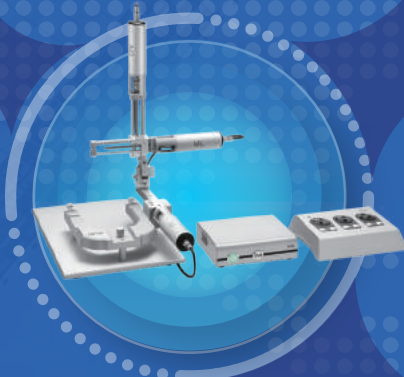

Animal Surgery and  
Modeling Solution



Animal Administration and  
Blood Sampling Solution



Contact our distributor

**ANIMA**  **LAB**  
animal facility and laboratory equipment • animal research models

[info@animalab.eu](mailto:info@animalab.eu) [www.animalab.eu](http://www.animalab.eu)